



**Monmouth  
Scientific**  
[www.cleanroomkits.co.uk](http://www.cleanroomkits.co.uk)



**Monmouth  
Scientific**  
[www.cleanroomkits.co.uk](http://www.cleanroomkits.co.uk)



# Cleanroom Kits

# Installation Guide



## Guide Contents

Introduction: .....	6
Tools that you will need: .....	6
Safety & Disclaimer Notice .....	7
Complete Parts List .....	8
Unions? .....	15
Union Parts.....	15
How does the Union Work?.....	16
The Union in the Monmouth Cleanroom: .....	17
Joining two pieces:.....	19
Fitting a panel: .....	21
Fitting a ceiling tile support: .....	23
Standard Wall Panel.....	24
Door Panels .....	25
Door .....	26
Ceiling Assembly .....	27
4M – 2m x 2m room.....	27
4Mplus – 2m x 2m room with 1m x 2m atrium .....	28
6M – 3m x 2m room.....	29
6Mplus – 3m x 2m room with 1m x 2m atrium .....	30
9M – 3m x 3m room.....	31
9Mplus – 3m x 3m room with 1m x 3m atrium .....	32
12M – 4m x 3m room.....	33
12Mplus – 4m x 3m room with 1m x 3m atrium .....	34
Using CAM1000 in 9M, 9M+, 12M & 12M+.....	35
Top Door Runner Assembly .....	36
Hanging the door(s) .....	37
Bottom Door Runner Assembly .....	38
Soft Close Door Adjustment.....	39
Room Assembly.....	41
WARNINGS.....	41
Installing Clean Air Modules (CAM) .....	47
CAM1000.....	48
Introduction .....	48
Installation .....	49
Setting the fan speed .....	50
Maintenance.....	51

Changing the pre-filters .....	51
Changing the HEPA filter .....	51
CAM1000 Replacement Filter Part Numbers.....	51
CAM2250.....	52
Introduction .....	52
Installation .....	53
System Set-up .....	54
CAM Module Connections .....	54
Setting the fan speed .....	55
Calibration of the low-airflow alarm.....	56
Maintenance .....	56
Changing the pre-filters .....	56
Replacement filter part numbers.....	56
Colour Coded Aluminium Framework – without panels .....	57
4M – 2m x 2m room           4Mplus – 2m x 2m room with 1m x 2m atrium.....	57
6M – 3m x 2m room.....	58
6Mplus – 3m x 2m room with 1m x 2m atrium .....	59
9M – 3m x 3m room.....	60
9Mplus – 3m x 3m room with 1m x 3m atrium .....	61
12M – 4m x 3m room.....	62
12Mplus – 4m x 3m room with 1m x 3m atrium .....	63
Complete Cleanroom Layouts - .....	64
4M – 2m x 2m room           4Mplus – 2m x 2m room with 1m x 2m atrium .....	64
6M – 3m x 2m room.....	65
6Mplus – 3m x 2m room with 1m x 2m atrium .....	66
9M – 3m x 3m room.....	67
9Mplus – 3m x 3m room with 1m x 3m atrium .....	68
12M – 4m x 3m room.....	69
12Mplus – 4m x 3m room with 1m x 3m atrium .....	70
Questions and Support .....	71

## Introduction:

### **IMPORTANT: PLEASE READ AND UNDERSTAND THESE INSTRUCTIONS IN FULL BEFORE STARTING ANY ASSEMBLY.**

Welcome to the Cleanroom Kits installation guide. This document will take you through the set-up and installation of your cleanroom. Please remember that handing of doors is possible and that positions of doors, windows and lights are all interchangeable so it is impossible to give a 'screw by screw' account of every permutation.

It is important that you FULLY understand how each section of the room goes together as this will help you in planning the exact layout of your room. Therefore, PLEASE READ AND UNDERSTAND THESE INSTRUCTIONS IN FULL BEFORE STARTING ANY ASSEMBLY.

Please check all the parts are present and familiarise yourself with them. There are occasional necessary subtle differences between parts and it is important they are not used in the wrong locations. Lengthy errors can be avoided by understanding the system.

Assembly of the room is a two person process – do not attempt to build the room on your own. Significant injury can occur when lifting or moving heavy parts. Construction time of the room will vary depending upon expertise and room size. Please do not rush and ensure you understand the process at each stage. If in doubt, ask!

Start with a clear area and make sure you have enough space to install the cleanroom including enough height.

Make sure you have all the necessary tools available and adhere to all safety instructions when using tools or devices. We recommend using safety glasses at all times when assembling the room.

When lifting the CAM (Clean Air Modules) into place on the ceiling, you must ensure the structure is complete and fully tightened prior to placement. We also strongly recommend the use of a suitable lifting device such as a Genie lift (can be hired from any good tool shop) to minimise the risk of personal injury or damage to the product.

## Tools that you will need:

- 4mm Allen Keys (2no. provided)
- 3mm Allen Key (provided)
- White Faced Rubber Mallet (provided)
- Safety Glasses – to be worn at all times
- 10mm & 13mm spanners
- Suitable ladders
- Lifting Device
- Spirit Level
- Tape Measure
- Clear Silicone (Optional)
- Silicone Gun (Optional)

## Safety & Disclaimer Notice



In order to assemble this room you must be fully competent in all tasks associated with assembly.

All personnel must be suitably trained in the use of any equipment used during the installation of this Cleanroom Kit. It is the customer's responsibility to ensure the safety of all colleagues and personnel carrying out this task. Monmouth Scientific Limited does not accept responsibility for any injury or damage howsoever caused.









Any electrical work necessary should be carried out by a qualified electrician.



If at any time, you are not comfortable with any aspect of the installation then STOP and seek professional assistance.

Monmouth Scientific can provide free-of-charge support on the telephone by calling +44 1278 458090 during normal office hours or will happily provide an installation service. Please contact us for a quotation if you wish to use the installation service.







## Complete Parts List





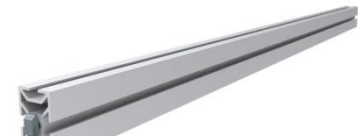

Number on drawings:		Length	Qty								Monmouth Part No.
			4M	4M+	6M	6M+	9M	9M+	12M	12M+	
1	 Lower Wall Bar	970mm	7	10	9	12	11	15	13	17	30100-PA-970
2	 Mid Wall Bar	970mm	7	10	9	12	11	15	13	17	30100-2PA-970
3	 Top Wall Bar with side filler strip	970mm	8	10	10	12	12	14	14	16	3050-PA-FS-970
4	 Top Wall Bar (for internal walls)	970mm	0	2	0	2	0	3	0	3	3050-PA-970
5	 Plastic Reducer Strip	1045mm	26	36	34	44	42	56	50	64	PP-02371-1045
6	 Plastic Reducer Strip	735mm	2	4	2	4	2	4	2	4	PP-02371-735
7	 Plastic Reducer Strip	205mm	4	8	4	8	4	8	4	8	PP-02371-205
8	 Corner Post with foot	2350mm	3	3	3	3	3	3	3	3	3030C-FT-2350



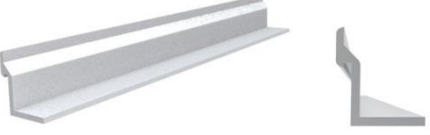
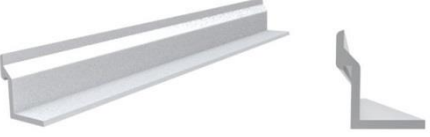















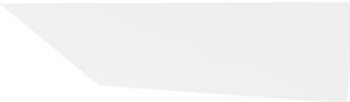

Number on drawings:	Image	Length	Qty								Monmouth Part No.
			4M	4M+	6M	6M+	9M	9M+	12M	12M+	
9	<p>Double faced post with foot (&amp; additional 25mm slot)</p>	2350mm	3	3	5	5	7	7	9	9	3030D-S-FT-2350
10	<p>Double faced post with foot (&amp; two additional 25mm slots)</p>	2350mm	0	0	0	0	0	1	0	1	3030D-2S-FT-2350
11	<p>Double faced post with foot and door runner (&amp; additional 25mm slot)</p>	2350mm	1	1	1	1	1	1	1	1	3030D-S-FT-2350
12	<p>Double faced post with foot and door runner (&amp; two additional 25mm slots)</p>	2350mm	0	1	0	1	0	1	0	1	3030D-2S-FT-2350
13	<p>Single Faced Post with foot</p>	2350mm	0	2	0	2	0	2	0	2	3030S-FT-2350
14	<p>Outer Door Post with foot</p>	2350mm	1	1	1	1	1	1	1	1	3060-FT-2350

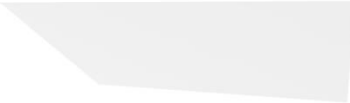
Number on drawings:	Image	Length	Qty								Monmouth Part No.
			4M	4M+	6M	6M+	9M	9M+	12M	12M+	
15	 Main Ceiling Beam (full width of room)	1970mm	1	1	2	2	0	0	0	0	3050-FS-1970
16	 Main Ceiling Beam (full width of room)	2970mm	0	0	0	0	0	0	0	0	3050-FS-2970
17	 Main Reinforced Ceiling Beam (full width of room)	3024mm	0	0	0	0	2	2	3	3	3050-FS-2970/30100-3030
18	 Standard Ceiling Beam 0° Connectors	970mm	2	2	2	2	2	2	4	4	3050-FS-970-0
19	 Standard Ceiling Beam 90° Connectors	970mm	0	1	0	1	0	2	0	2	3050-FS-970-90
20	 Standard Ceiling Beam (with alternate connectors 1no. 0° & 1no. 90° Connector)	970mm	1	1	2	2	4	4	4	4	3050-FS-970-0/90
21	 Ceiling Support Rail	919.5mm	8	12	12	16	16	22	22	28	MW-04473-919.5
22	 Ceiling Support Rail	969.5mm	4	8	8	12	16*	22*	22*	28*	MW-04473-969.5 *If ISO 8 CAM1000 selected then 4no. less 22 will be provided and substituted with 4no. 44





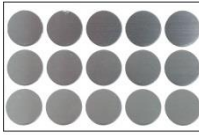

Number on drawings:		Length	Qty								Monmouth Part No.
			4M	4M+	6M	6M+	9M	9M+	12M	12M+	
42	 Ceiling Support Rail	622mm	4	4	4*	4*	0	0	0	0	MW-04473-419.5 (*only with CAM1000 in ISO8 6M or 6M+)
43	 Ceiling Support Rail	469.5mm	0	0	4*	4*	0	0	0	0	MW-04473-622 (*only with CAM2250 in ISO7 6M or 6M+)
44	 Ceiling Support Rail	1072 mm	0	0	0	0	4*	4*	4*	4*	MW-04473-419.5 (*only with CAM1000 in ISO8 9M,9M+, 12M or 12M+)
23	 Door Header - slotted	970mm	1	2	1	2	1	2	1	2	30100-PA-970SL
24	 Door Rail Support - slotted	970mm	1	2	1	2	1	2	1	2	30100-2PA-970SL
25	 Door	1995mm x 1000mm	1	2	1	2	1	2	1	2	Door
26	 Door Runner	1960mm	1	2	1	2	1	2	1	2	

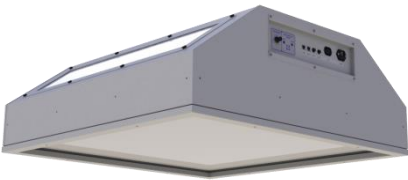

Number on drawings:		Length	Qty								Monmouth Part No.
			4M	4M+	6M	6M+	9M	9M+	12M	12M+	
27	 Door Runner Cover & end caps	1970mm	1	2	1	2	1	2	1	2	
28	 Standard White Wall Panel	1042mm x 980mm	11	15	14	18	17	22	20	25	
29	 Standard Clear Window Panel	1042mm x 980mm	2	3	3	4	4	6	5	7	
30	 Clear Window Panel – adjacent to door	731mm x 980mm	1	2	1	2	1	2	1	2	
31	 Part Clear Window Panel	980mm x 203mm	2	4	2	4	2	4	2	4	
32	 Standard White Ceiling Panel	960mm x 960mm	2	4	4	6	8*	11*	11**	14**	*If ISO 8 CAM1000 selected then 2no. less 32 will be provided and substituted with 2no. 45 **If 2no. CAM2250 are selected then 1no. less 32 will be provided
33	 Standard White Ceiling Panel with LED light and associated transformers and leads.	960mm x 960mm	Optional – supplied as ordered.								For each light ordered one less ceiling tile 32 will be supplied.

Number on drawings:		Length	Qty								Monmouth Part No.
			4M	4M+	6M	6M+	9M	9M+	12M	12M+	
34	 White Ceiling Panel	960mm x 612mm	2	2	2*	2*	0	0	0	0	(*only with CAM1000 in ISO8 6M or 6M+)
35	 White Ceiling Panel	960mm x 460mm	0	0	2*	2*	0	0	0	0	(*only with CAM2250 in ISO7 6M or 6M+)
45	 White Ceiling Panel	960mm x 1112mm	0	0	0	0	2*	2*	2*	2*	(*only with CAM1000 in ISO8 9M,9M+, 12M or 12M+)
36	 Socket Head Button Screw – M5x12mm		12	24	12	24	12	24	12	24	For use with door brackets
37	 Channel T-Nut – M5		12	24	12	24	12	24	12	24	For use with door brackets
38	 5mm washer		12	24	12	24	12	24	12	24	For use with door brackets
39	 Spare 0° Union		5	5	5	5	5	5	5	5	
40	 Spare 90° Union		5	5	5	5	5	5	5	5	
41	 End Caps	30mm x100mm	0	0	0	0	4	4	4	4	30100EC
48	 Union Cover Stickers	Sheet of 15	3 x 15	5 x 15	4 x 15	5 x 15	4 x 15	6 x 15	5 x 15	7 x 15	
49	 Electrical Trunking	1200mm	1	1	1	1	1	1	1	1	



Number on drawings:		Length	Qty								Monmouth Part No.
			4M	4M+	6M	6M+	9M	9M+	12M	12M+	
50	 CAM1000 Clean Air Module with support brackets (4) and power leads	ISO8	1	1	1	1	1	1	1	1	K-CAM1000
		ISO7	1	1	0	0	0	0	0	0	
51	 CAM1000 Control Panel	ISO8	1	1	1	1	1	1	1	1	
		ISO7	1	1	0	0	0	0	0	0	
46	 CAM2250 Clean Air Module with support brackets (4) and power leads	ISO8	0	0	0	0	0	0	0	0	K-CAM2250 *Optionally 2no.
		ISO7	0	0	1	1	1	1	1*	1*	
47	 CAM2250 Control Panel	ISO8	0	0	0	0	0	0	0	0	
		ISO7	0	0	1	1	1	1	1	1	
90	 4mm Allen Key (Colours vary)	4mm	2	2	2	2	2	2	2	2	
91	 3mm Allen Key (Colours vary)	3mm	1	1	1	1	1	1	1	1	
92	 White Rubber Mallet		1	1	1	1	1	1	1	1	

## Unions?

The unions are the 4 part connectors that provide the basis for joining the aluminium extrusions making up your cleanroom. There are two primary different union types, one at 0° and one at 90°.



**0° Union**



**90° Union**



A third 'double' union (to join mitres) is used on the doors, but the doors are pre-assembled for your convenience.

## Union Parts

Each primary union consists of 4 parts:



m8 grub screw  
11.8mm Ø barrel  
Spring  
10mm Ø draw bar



When assembled, the point of the grub screw must locate into the indent in the draw bar so the correct orientation of the drawbar is essential.

## How does the Union Work?

The unions all work in the same way. When the union is assembled into the aluminium correctly, the grub screw is tightened which pushes the point of the grub screw into the dimple on the draw bar and pulls the head of the drawbar toward the end of the Aluminium profile. This traps the adjoining profile into position. Small teeth in the underside of the head of the bar aid this process by gripping into the adjoin profile.

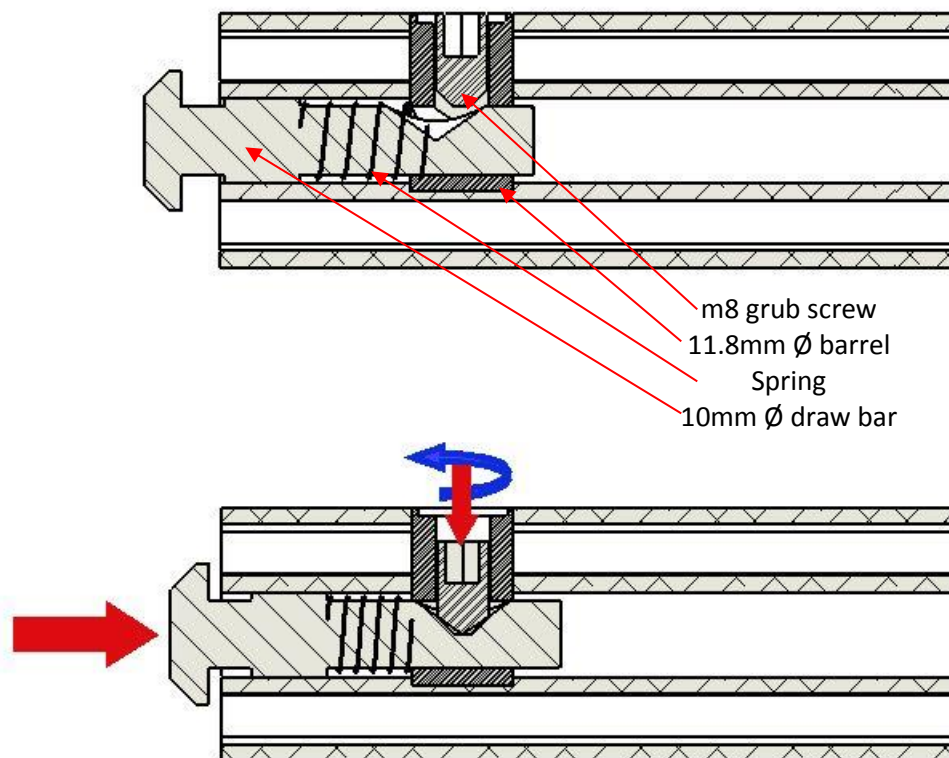



## The Union in the Monmouth Cleanroom:

Every joint of two aluminium profiles follows the same principle. In most (if not all) the union is supplied fitted into the Aluminium profile, however for the sake of clarity we will describe how to fit a union into the Monmouth profile.

1.



Take the aluminium profile with a 12mm $\varnothing$  hole.

2.



Fit the barrel into the 12mm $\varnothing$  hole with the barrel cross-hole parallel to the hole in the aluminium profile.

3.

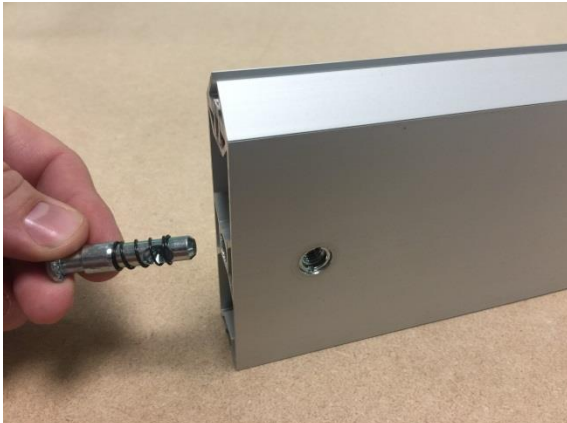

Place the spring over the draw bar and insert them both into the aluminium and push through the barrel.

4.

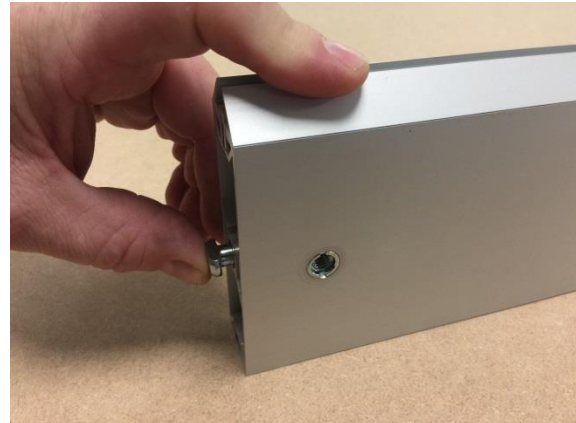

Push the draw bar in against the spring and ensure dimple on the side of the draw bar is visible in the hole of the barrel.

5.

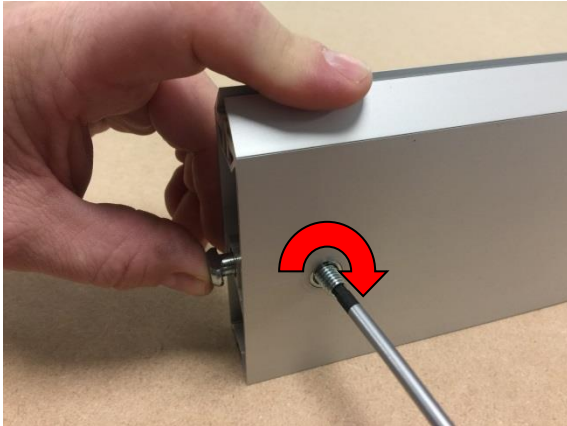

Insert the grub screw and using a 4mm allen hex key, tighten the grub screw.

6.

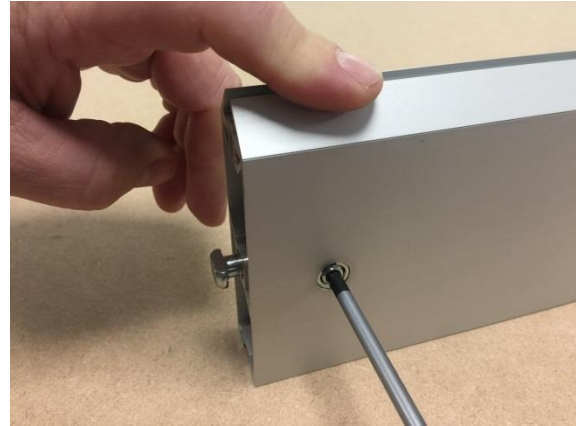

When the point of the grub screw enters the dimple of the barrel, you can release the barrel and it will stay assembled.

7.

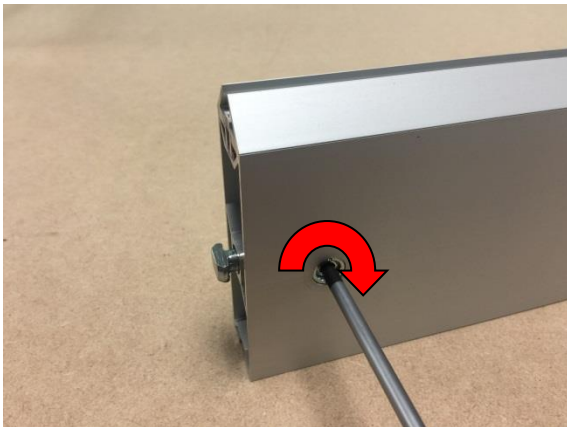

You should only tighten the grub screw so that at least 3mm of draw bar is visible behind the head of the fixing.

8.

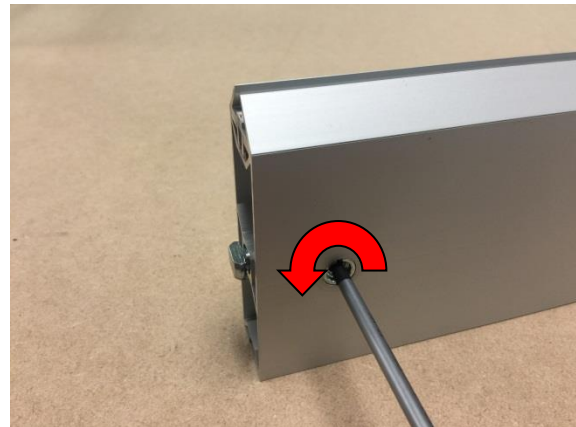

It is quite possible to over tighten making attachment to the next piece of aluminium impossible. In this case relax the grub screw until at least 3mm of draw bar is visible.

## Joining two pieces:

There are two simple methods of joining the aluminium using the union:

1.

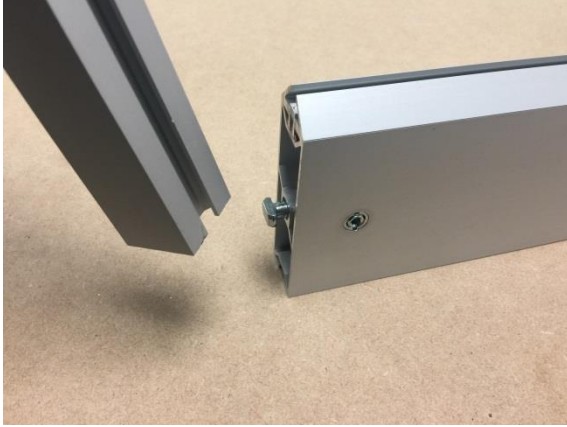

The first is to slide the aluminium into place down the connector.

2.



Slide to the desired position. Be careful to keep both pieces square as you may mark the aluminium.

3.



This second method is ideal when both ends of a piece need to locate into uprights. Line up the head with the slot at 90° from the required position and push in so the head can rotate freely in the slot.

4.

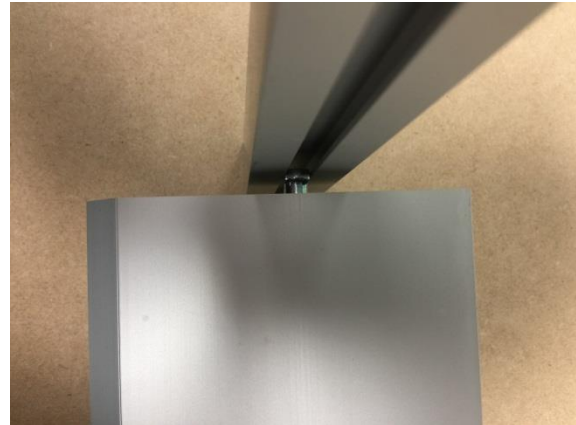

5.



Then rotate the whole piece back 90° slowly into the required position. Be careful to keep both pieces square as you may mark the aluminium. If the piece will not easily rotate, relax the grub screw slightly.

6.

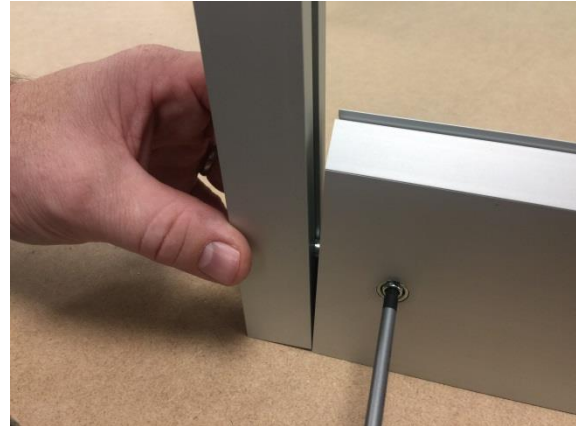

Hold the two pieces in the desired position

7.

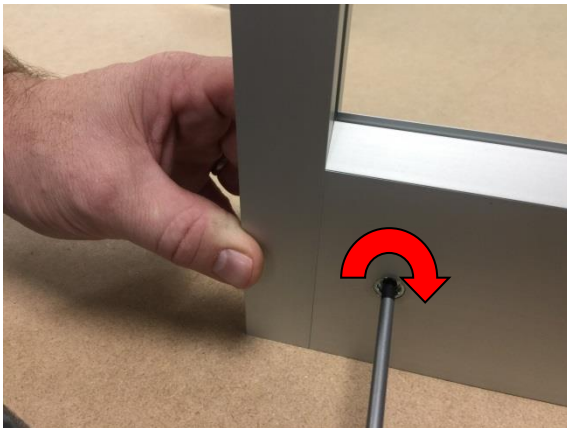

And tighten the grub screw to draw the two pieces together. Please ensure that the two sides are flush when being drawn together for the best joint.

8.

## Fitting a panel:

The same principles apply for panel fitting whether it is solid or clear.

1.



Ensure the slots in the aluminium line up. Adjust by loosening the grub screw if necessary.

2.



Horizontal slots will be fitted with the sloped reducer strip however vertical surfaces will need a plastic 8mm to 6mm reducer strip.

3.



Tuck the plastic reducer just behind the aluminium reducer for the best finish.

4.



Tap the plastic reducer strip in carefully along its entire length using a soft non-marking mallet. You can push in with fingers however this can be tough.



5.



Carefully check the size of the required sheet and its orientation. Peel away the protective sheet from BOTH sides of the sheet – if you wish to keep the sheet protected during assembly of the room, then just peel away from the edges.

6.



**OPTIONAL:** Should you wish the structure to be more permanent, then in each channel you can add a **SMALL** bead of clear silicone sealant (not supplied) before inserting the panel. This will stop any movement in the panel once fitted however it will be more difficult to take apart should you wish to relocate the room.

If you choose to do this and silicone squirts out from the sides of the panel and becomes visible, then you are using too much – **ONLY A SMALL AMOUNT IS REQUIRED.**

7.



Position the sheet into the slots as necessary. The sheet will slide in the slots however when sliding down between two uprights, it may be easier to loosen the grub screw on the joints.

8.



Ensure the sheet is located in all slots and **DON'T FORGET** to re-tighten the grub screws if you loosened them.

## Fitting a ceiling tile support:

The same principles apply for panel fitting whether it is solid or clear.

1.

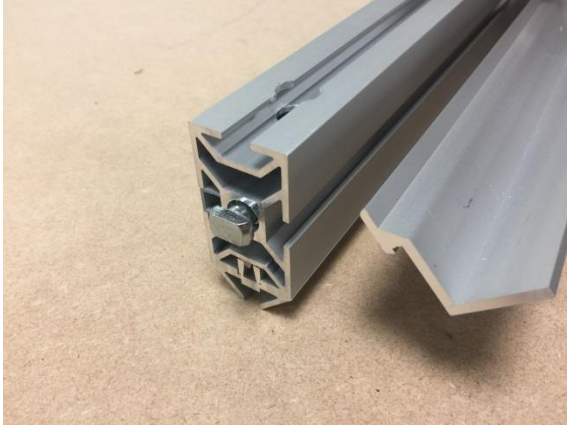

Tilt the ceiling support before offering to the slot.

2.

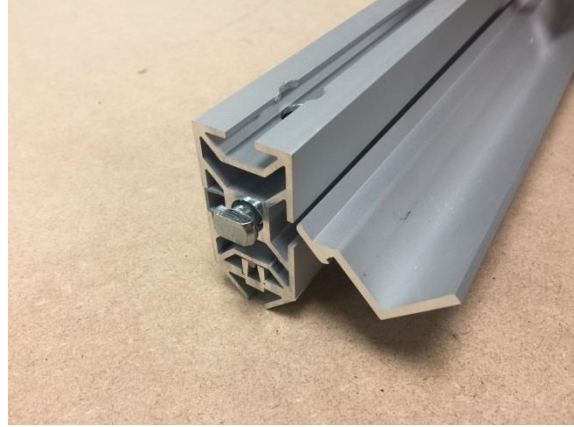

Move the leading edge of the ceiling support toward the slot ensuring the two pieces are parallel.

3.

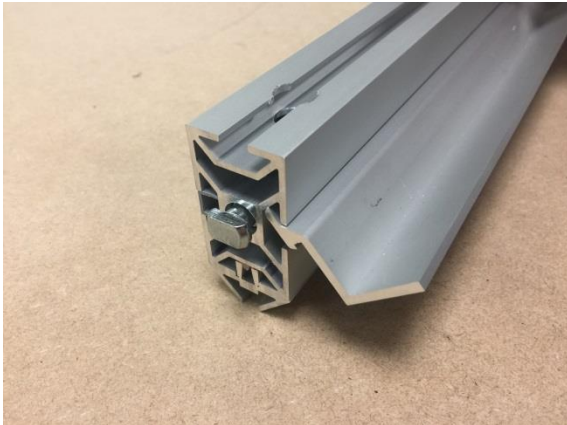

Tuck the leading edge of the ceiling support into the slot.

4.

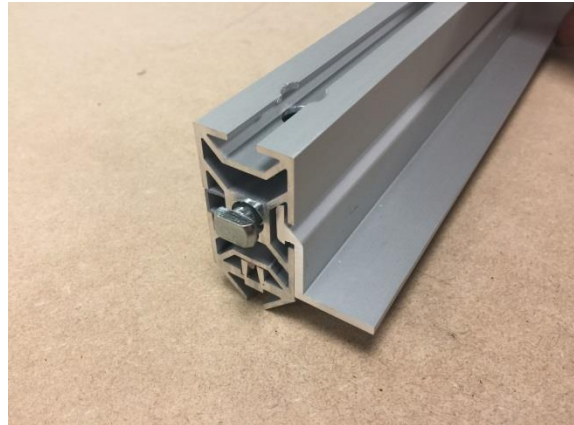

Tip the support downwards

5.

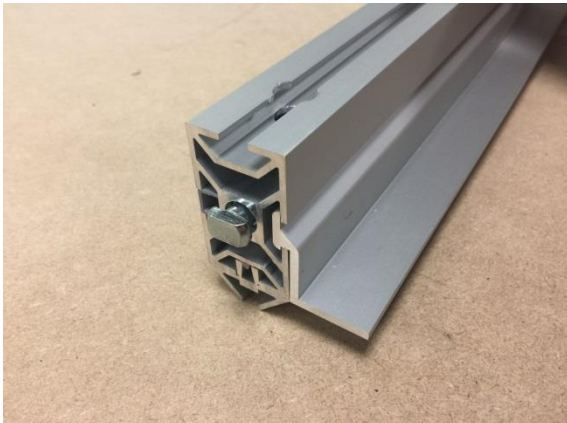

And allow to drop into position.

6.

## Standard Wall Panel

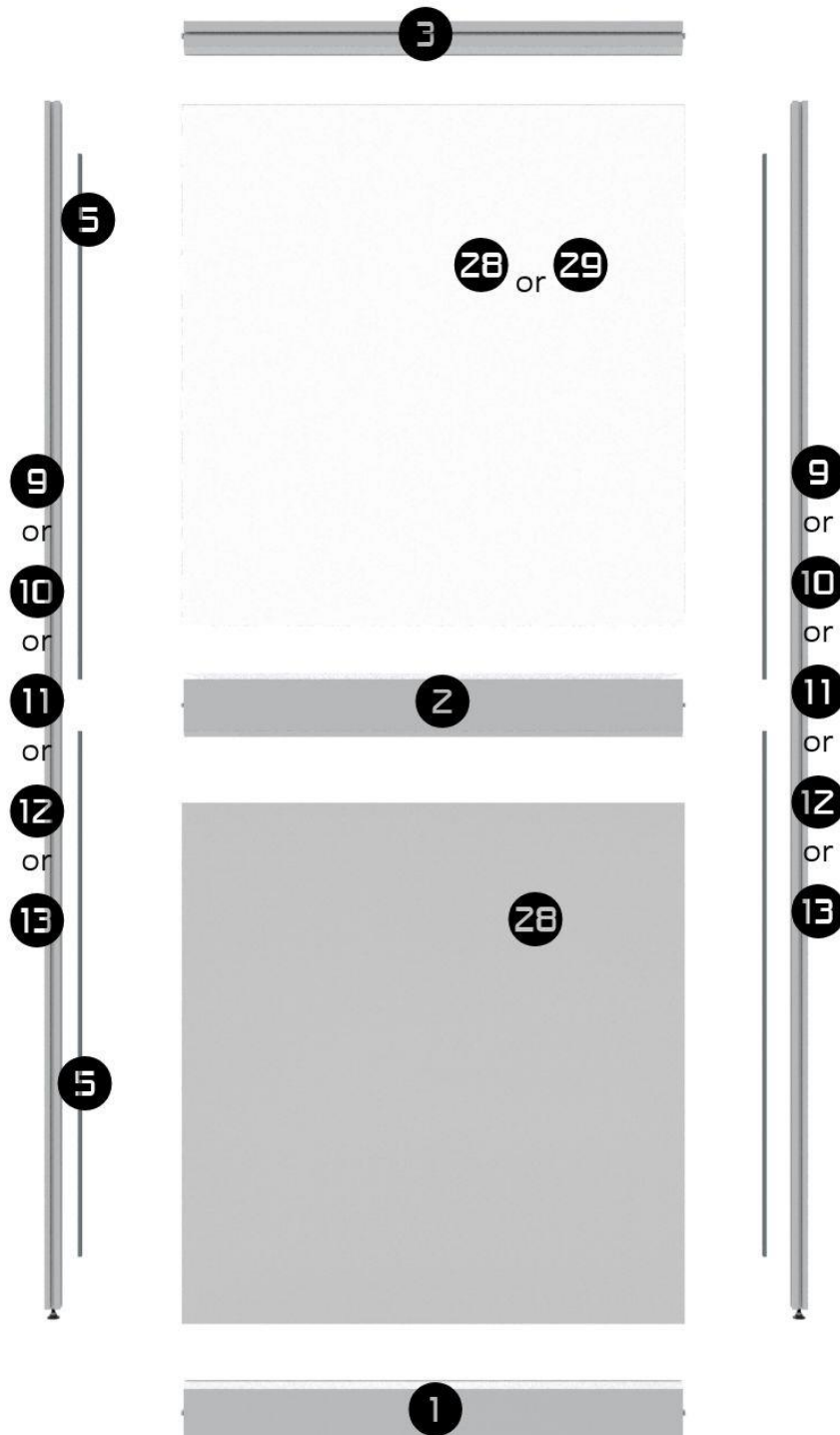



## Door Panels

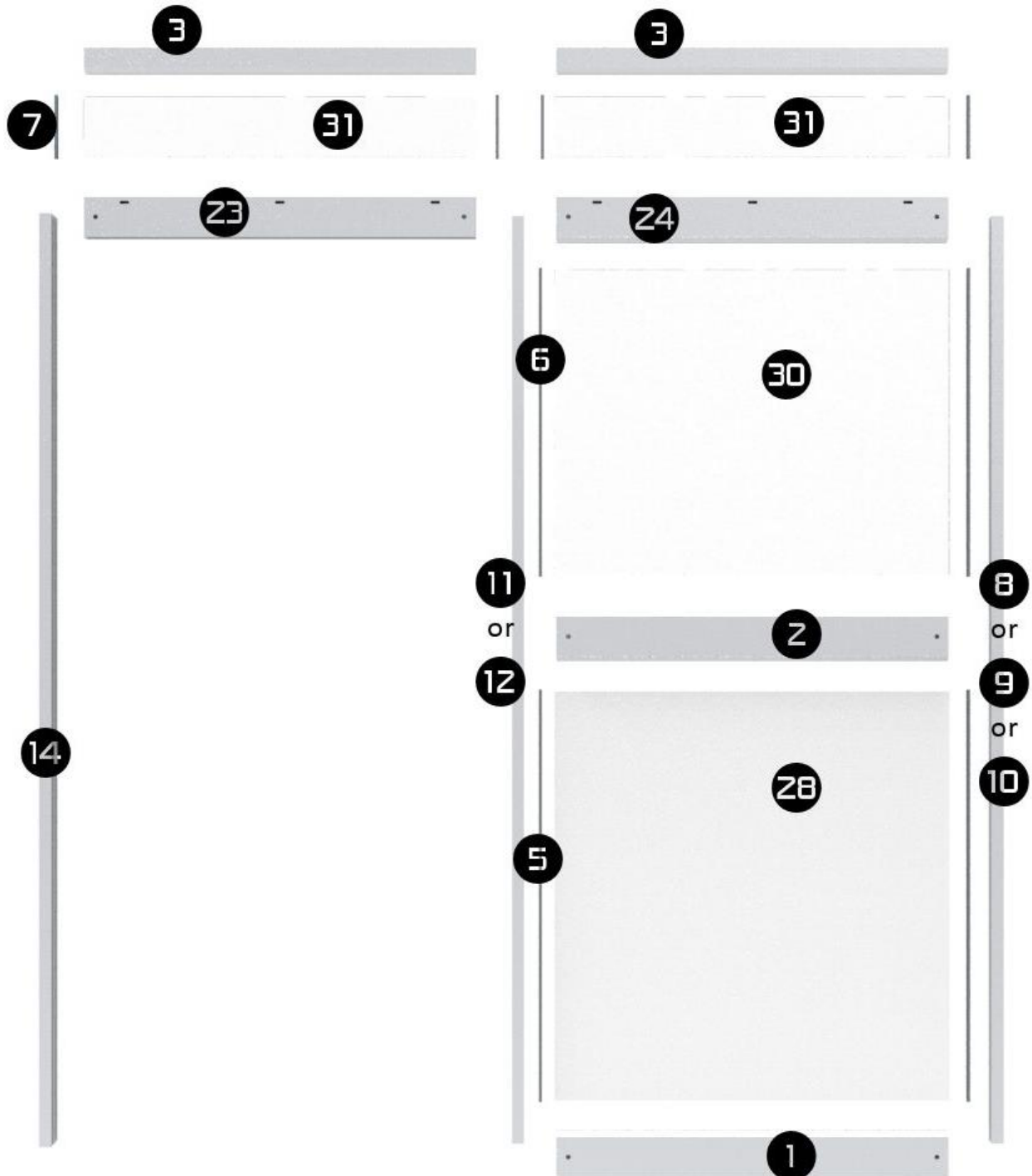

## Door

Door is supplied fully assembled – however for reference exploded view below:

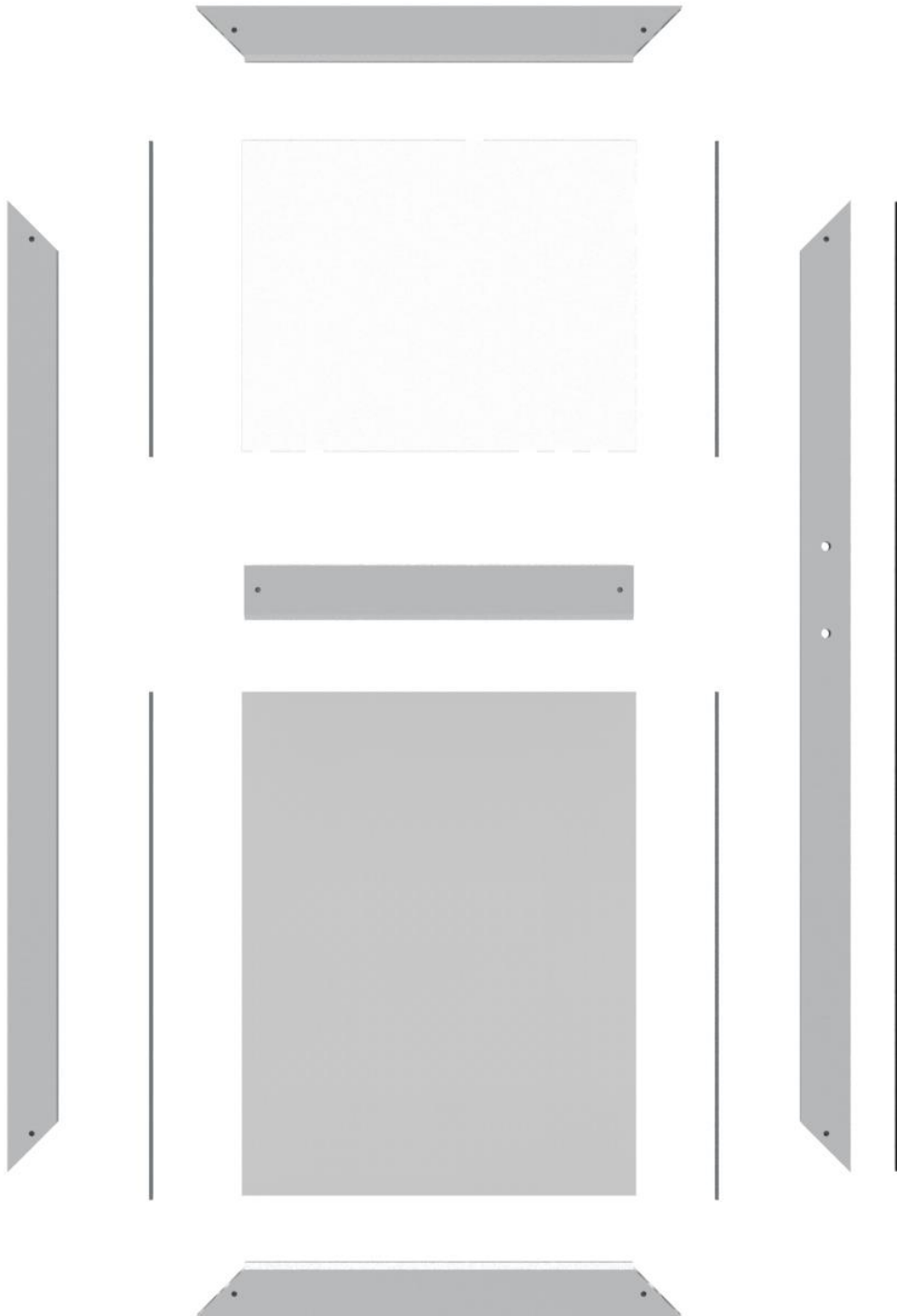

## Ceiling Assembly

### 4M - 2m x 2m room

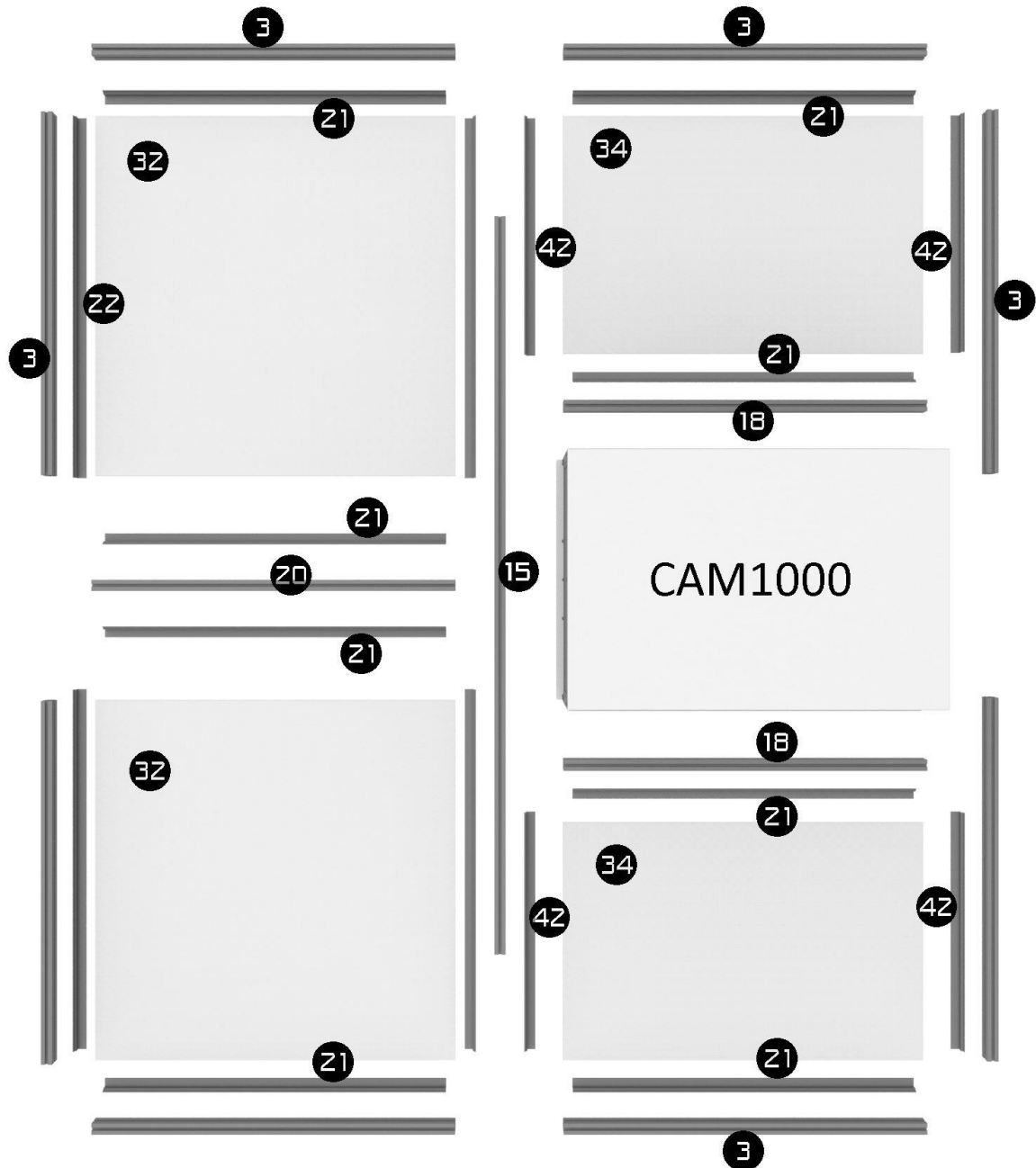

4Mplus - 2m x 2m room with 1m x 2m atrium

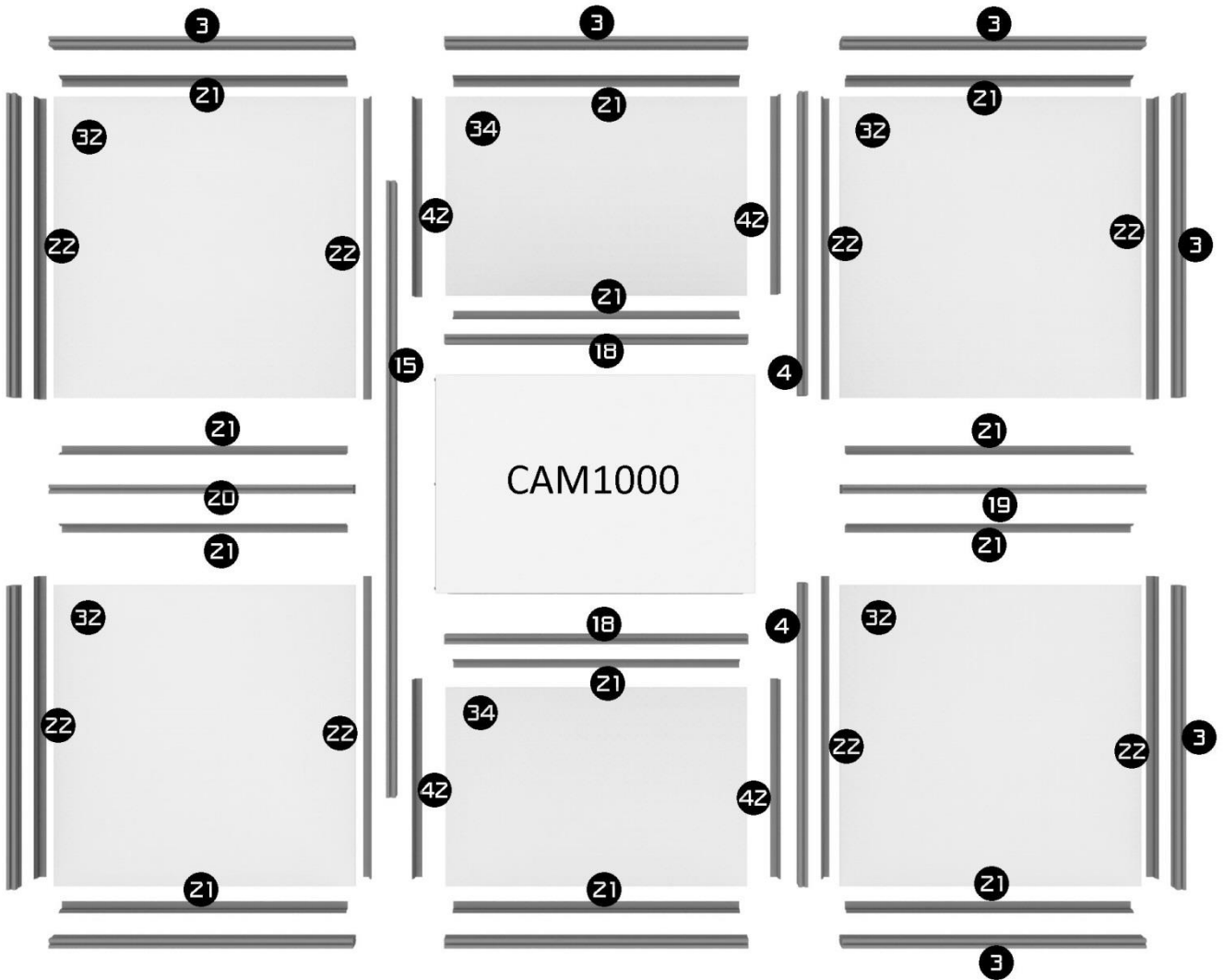

6M – 3m x 2m room

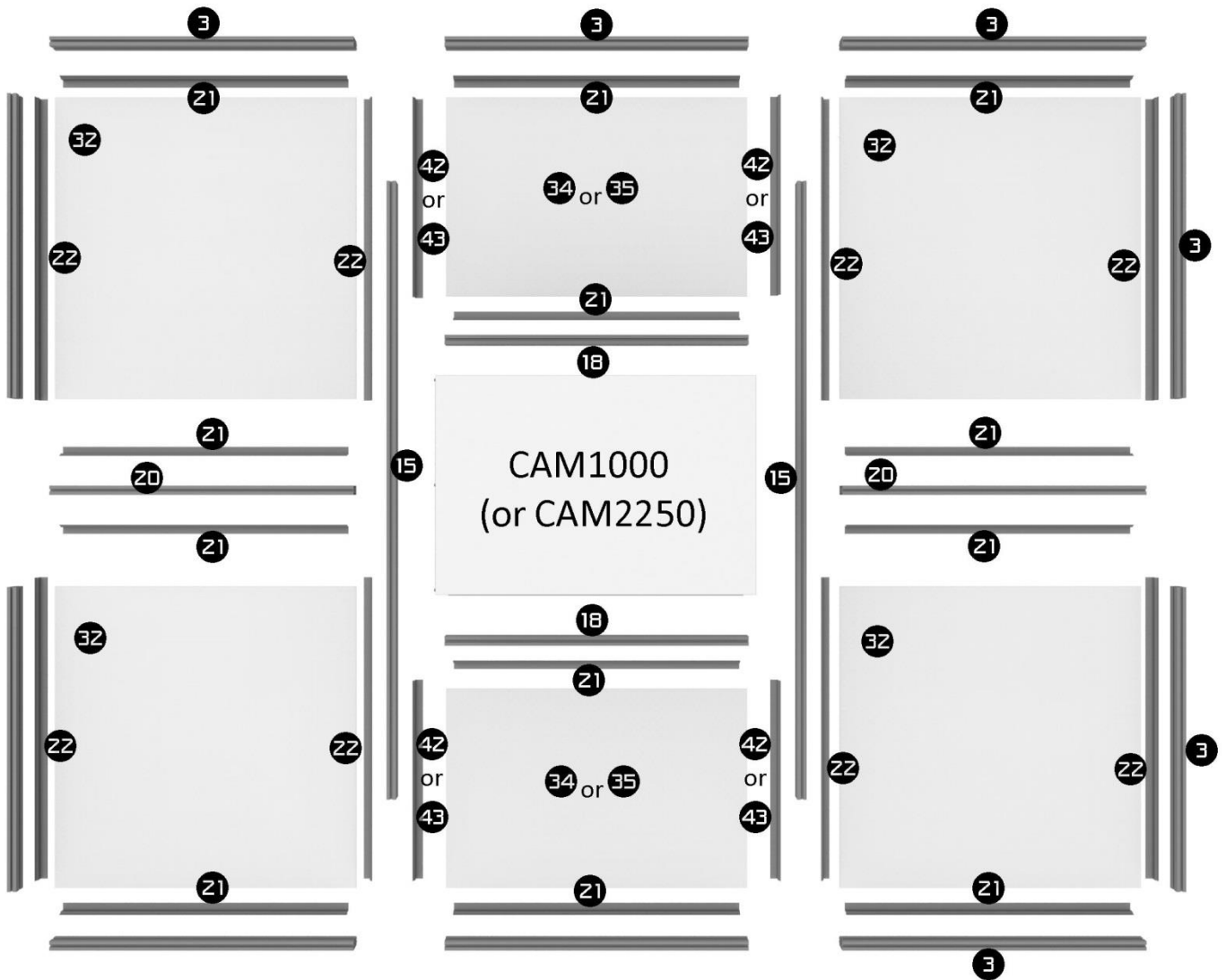

6Mplus – 3m x 2m room with 1m x 2m atrium

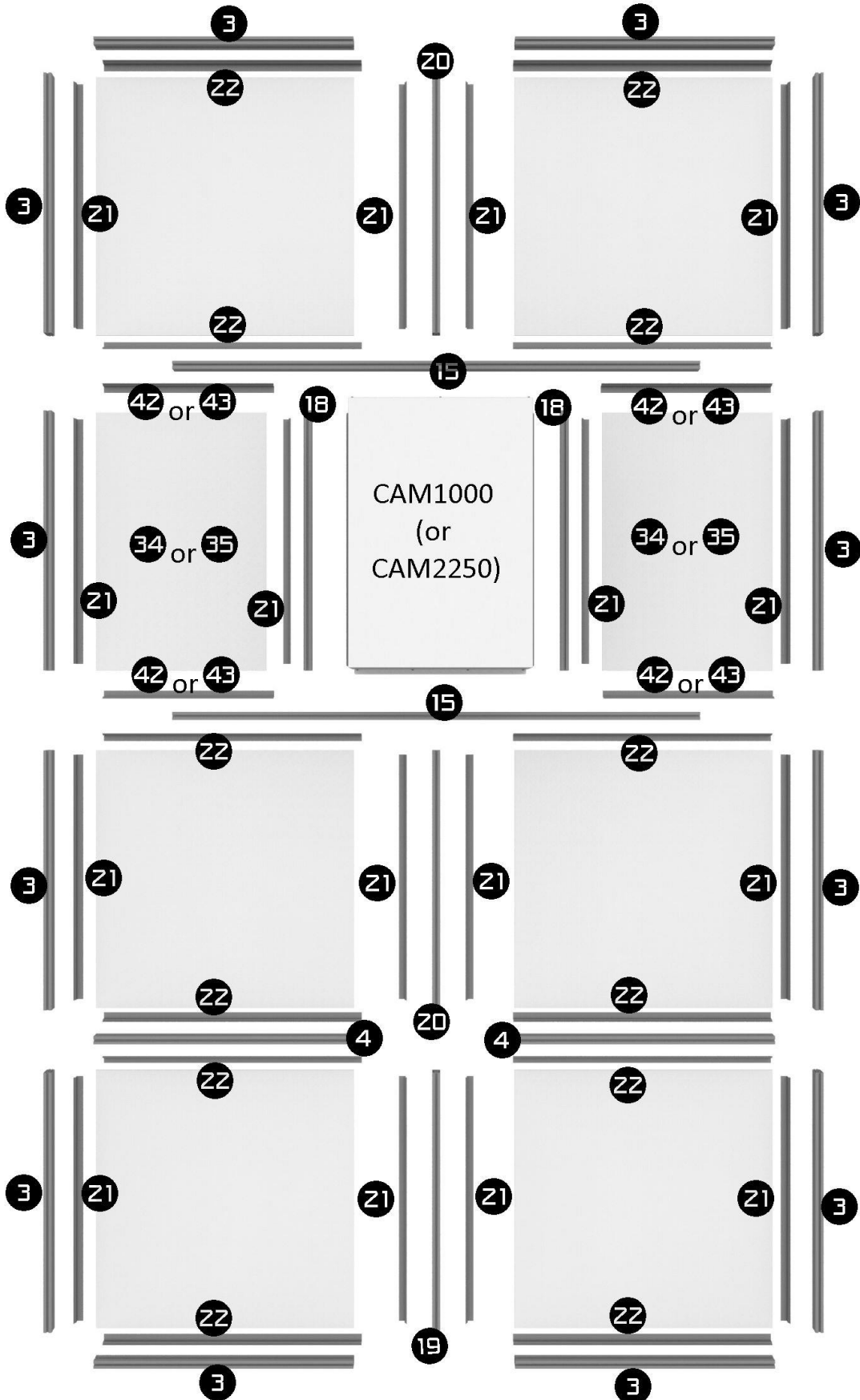

9M – 3m x 3m room

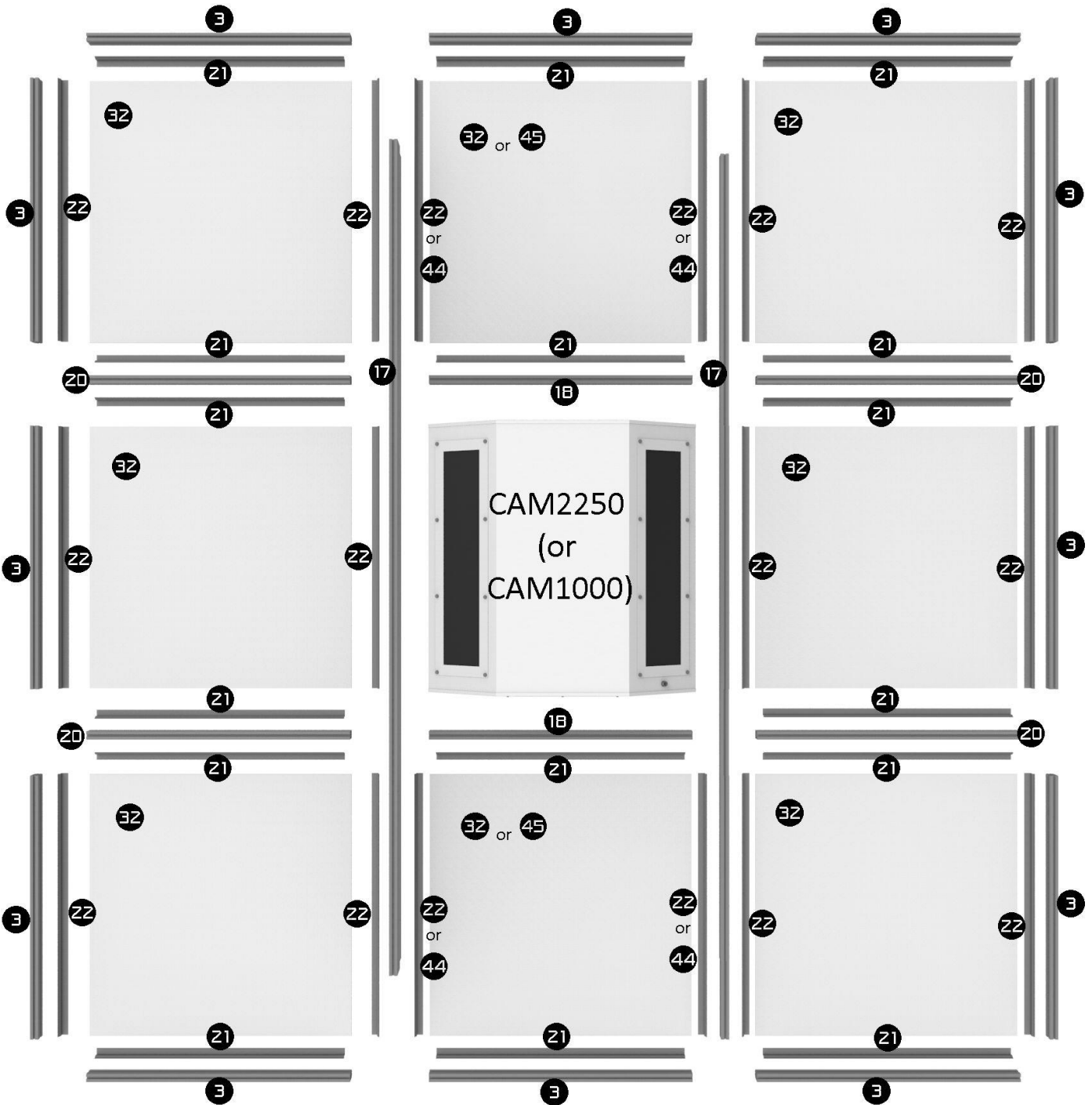

If using the CAM1000 and not the CAM2250, please see the additional parts included on page 34

**9Mplus – 3m x 3m room with 1m x 3m atrium**



If using the CAM1000 and not the CAM2250, please see the additional parts included on page 34



12M - 4m x 3m room

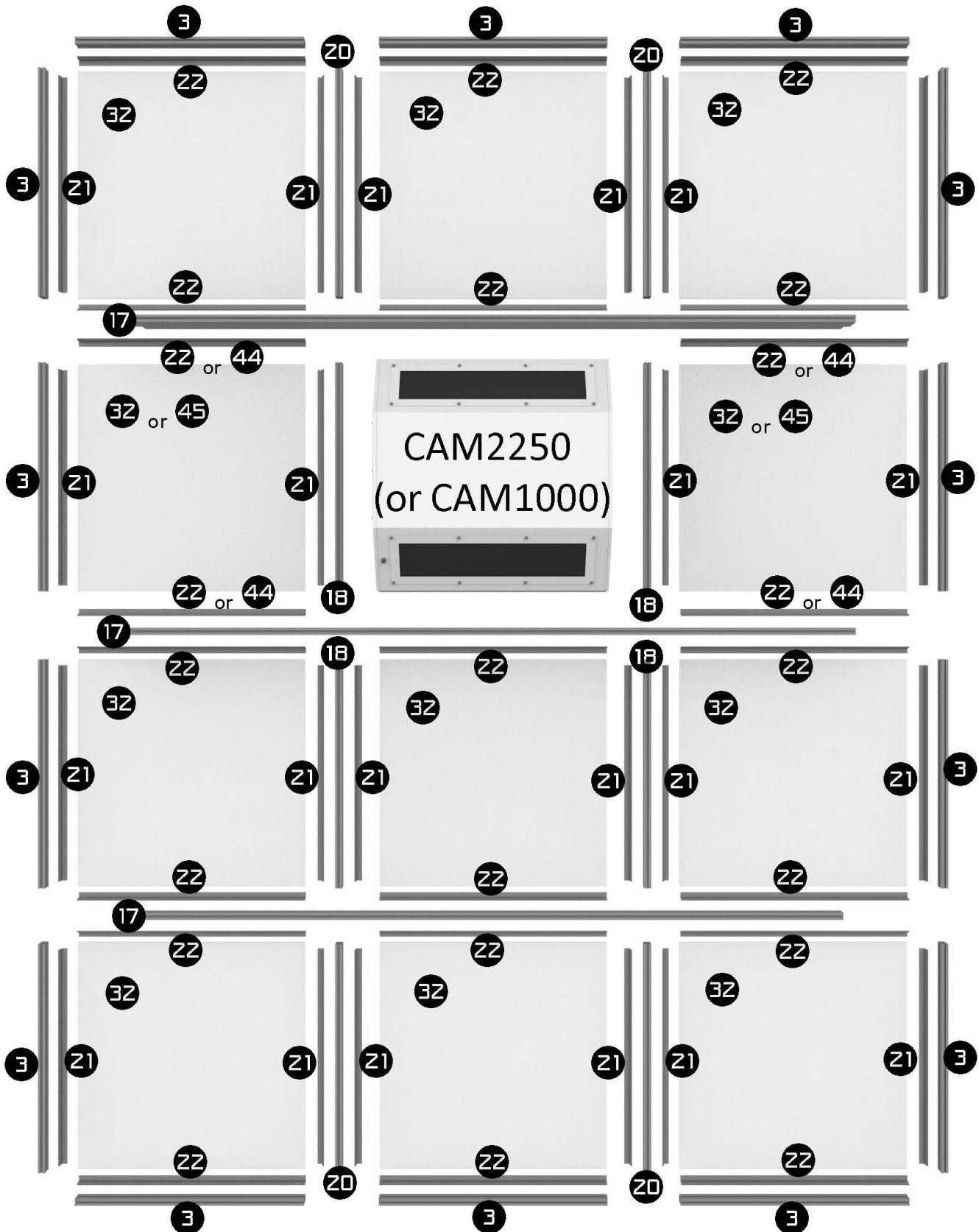

If using the CAM1000 and not the CAM2250, please see the additional parts included on page 34

12Mplus - 4m x 3m room with 1m x 3m atrium

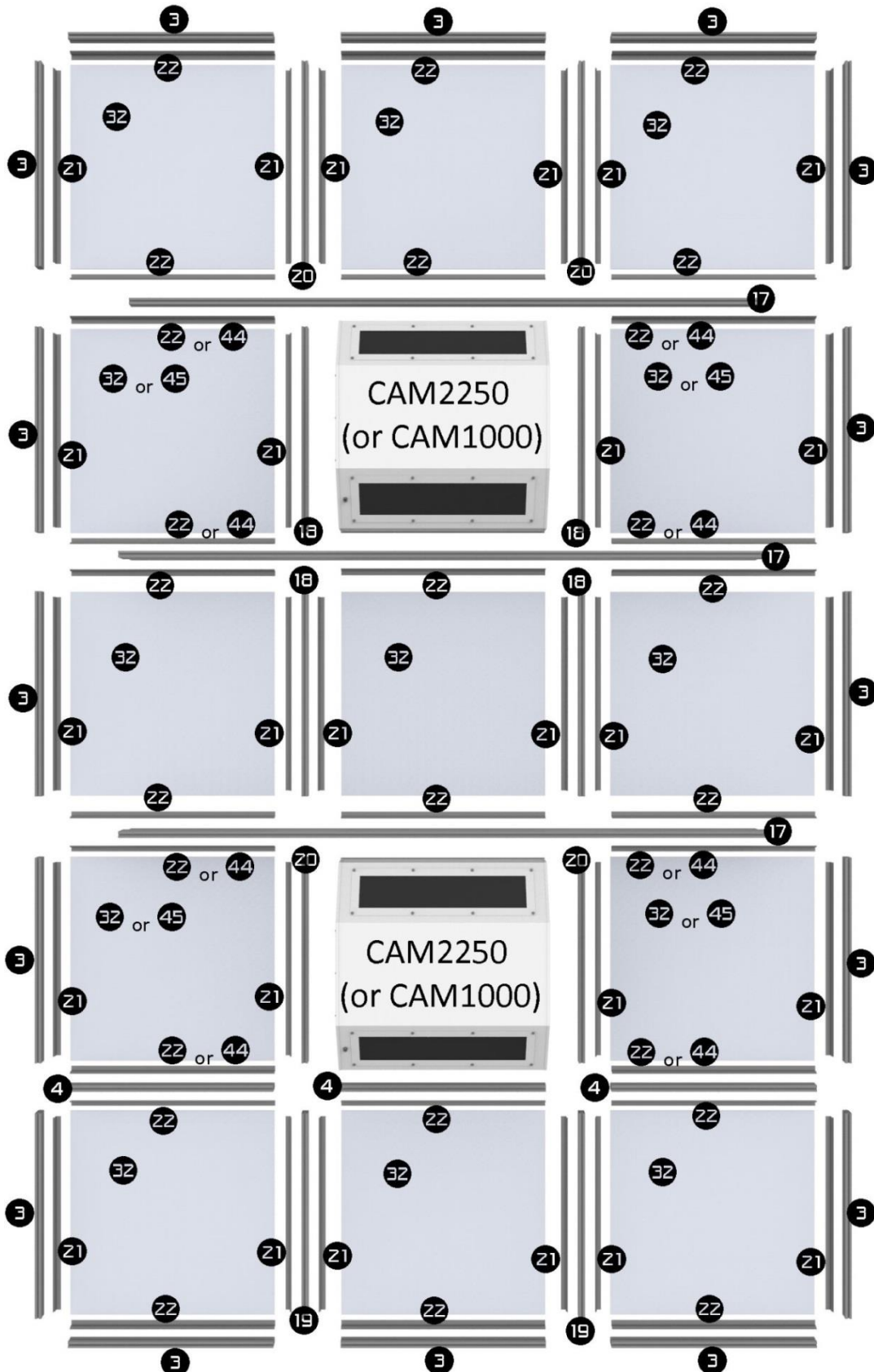

If using the CAM1000 and not the CAM2250, please see the additional parts included on page 34

## Using CAM1000 in 9M, 9M+, 12M & 12M+

## Top Door Runner Assembly

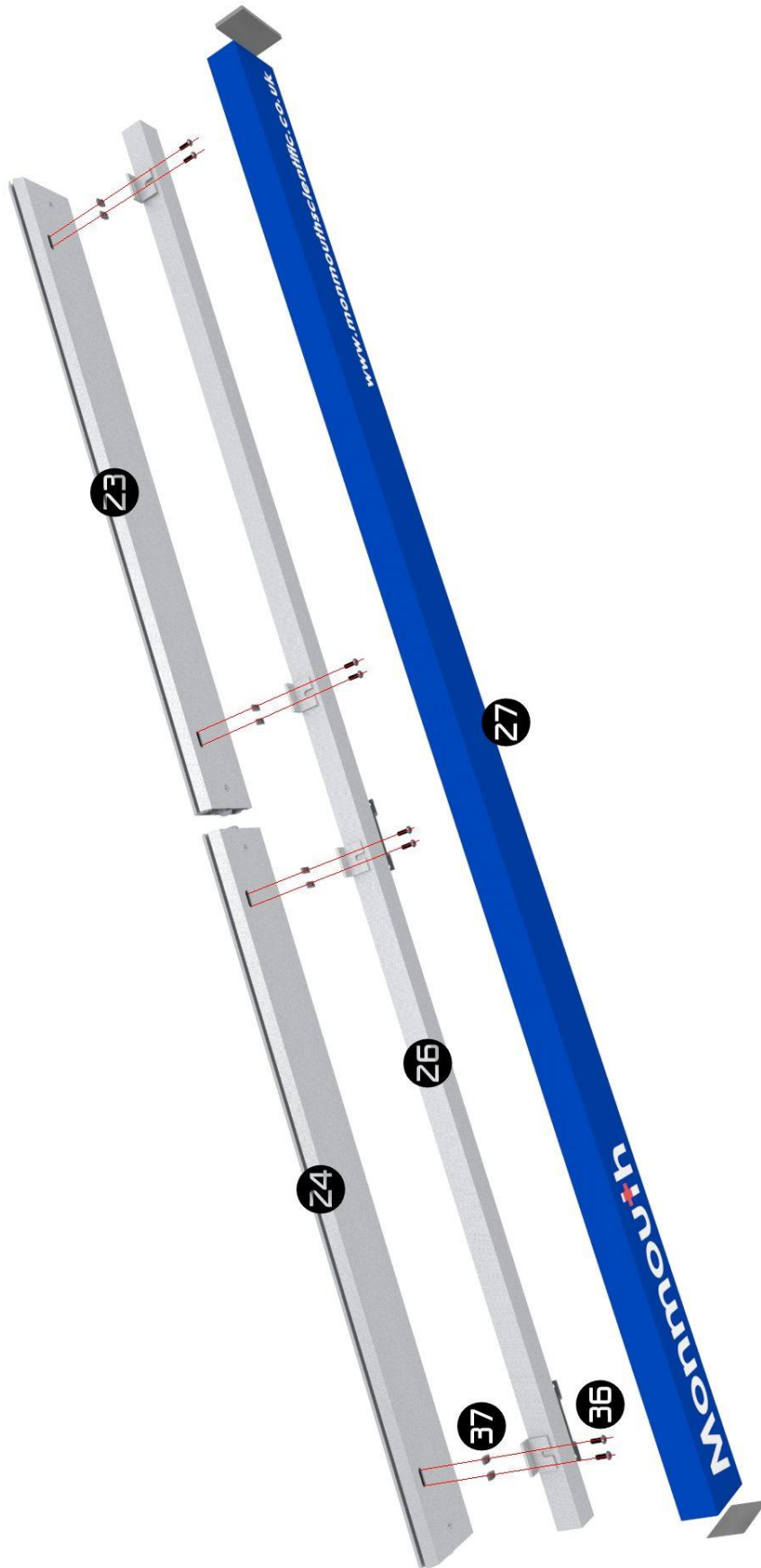

Care should be taken when attaching the door rails.

The rail 25 will fit onto the slotted door header 23 and door rail support 24. You may need to slide the brackets on the rail to match up with the slots.



Use M5x12 Button Screws 35, M5 Washers 36 and M5 Channel T-nuts 37.



Insert the channel nuts into the slot already fixed loosely to the bracket.

When you tighten the Button Screws with the allen key, the channel nut will turn through 90 – as you continue to tighten it will stay in position and clamp the bracket.

Once in position, tighten the brackets to the rail with a 10mm spanner.

## Hanging the door(s)



When the rail is sited hang the door from the M8 bolts fitted into the door carriage runners inside the rail using the two metal brackets fitted to the top of the door and tighten using a 13mm spanner.



When the door is hung, move slowly to the maximum desired opening position and set the end-stop to touch the door carriage. Tighten this in place using a 10mm spanner.

If a soft close is fitted this will need adjusting as below.

We advise fitting the Door Rail Cover 27 and end brackets on completion of the room.

## Bottom Door Runner Assembly

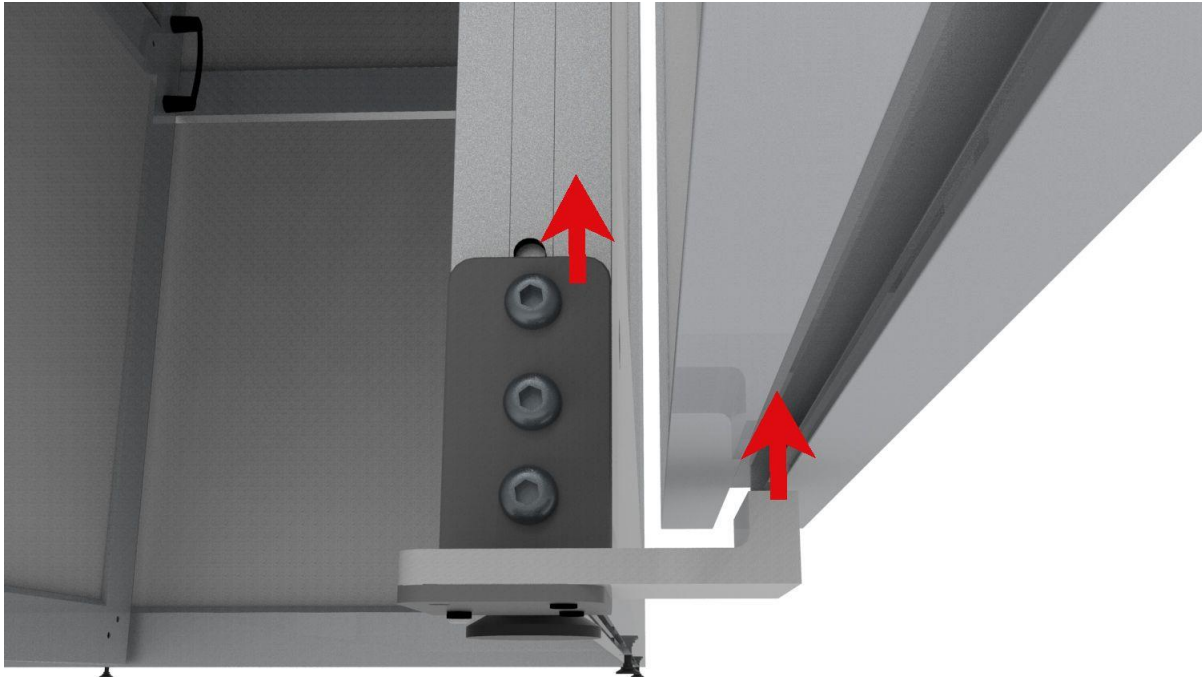

Bottom door runner will need adjustment. Loosen three retaining fixings and slide up/down ensuring that the runner locates in the bottom groove of the door. You should ensure the weight of the door is NOT resting on the runner.

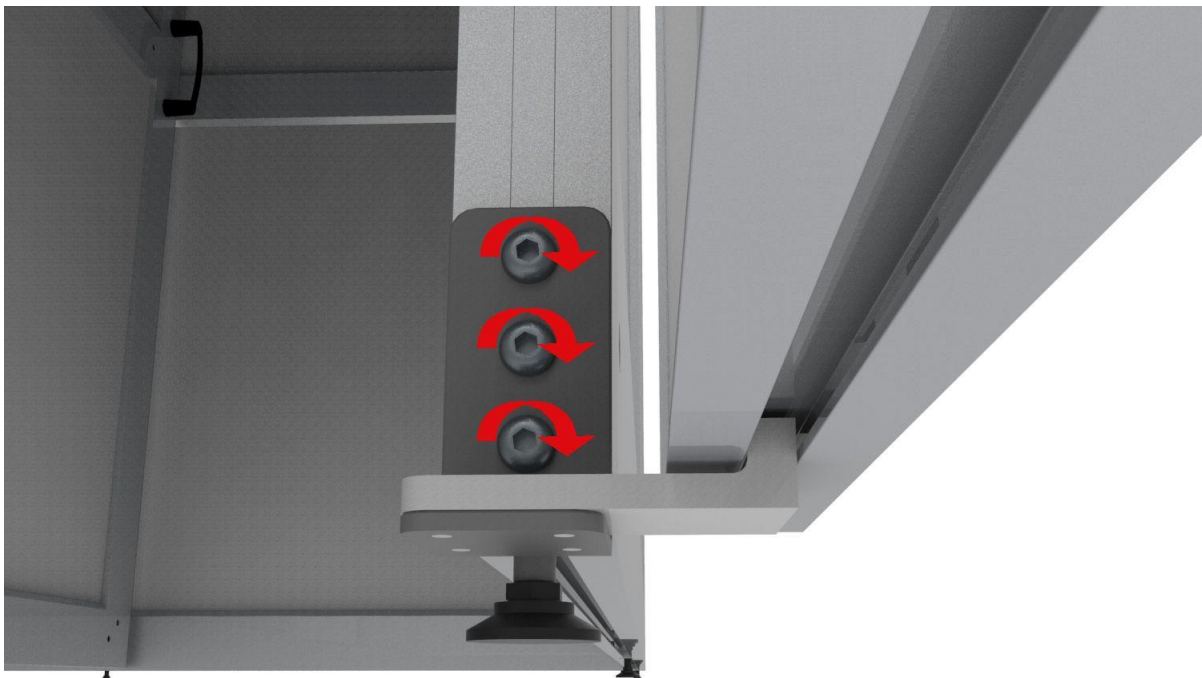

Once the door runner is adjusted, tighten the three retaining screws. Operate the door several times and re-adjust the height of the bracket as necessary. The bottom of the door should not rub on the white bracket at all.

## Soft Close Door Adjustment

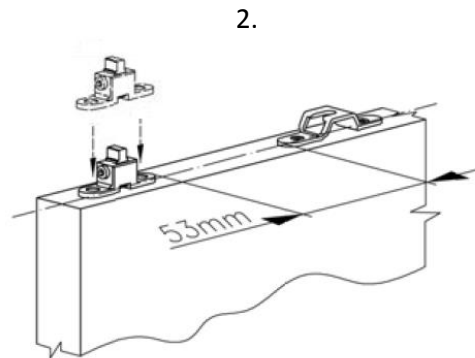
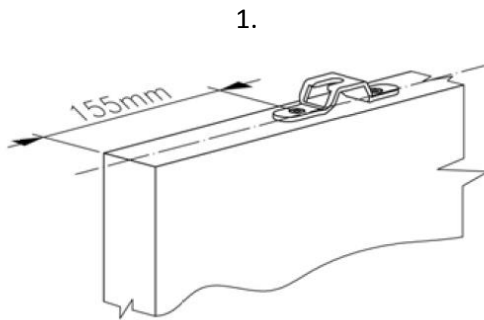

Fixtures on top of door are fitted with M5 Channel T-Nuts & M5 Screws

35 & 36

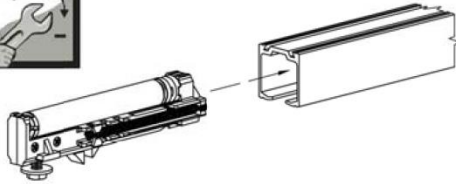

3.

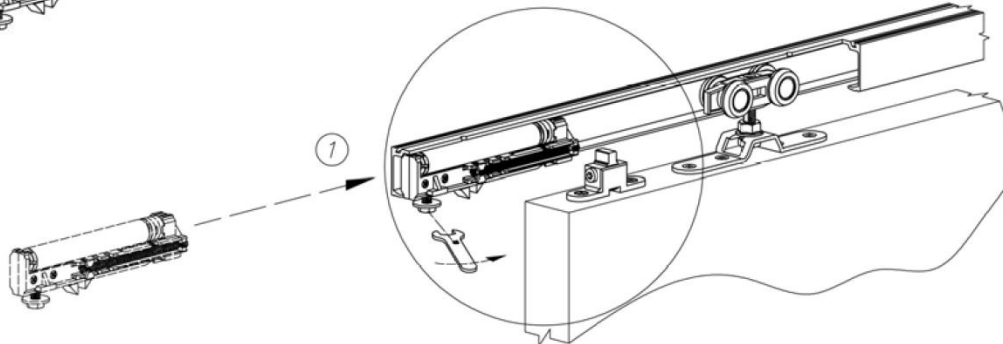

4.

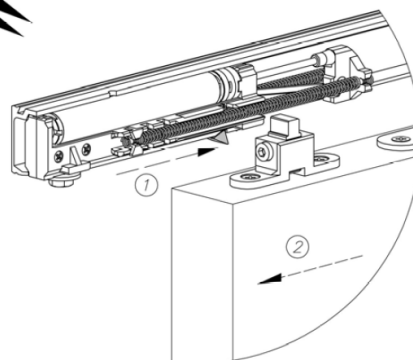
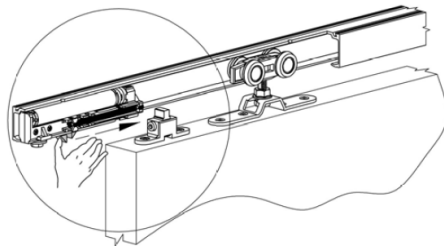

5.

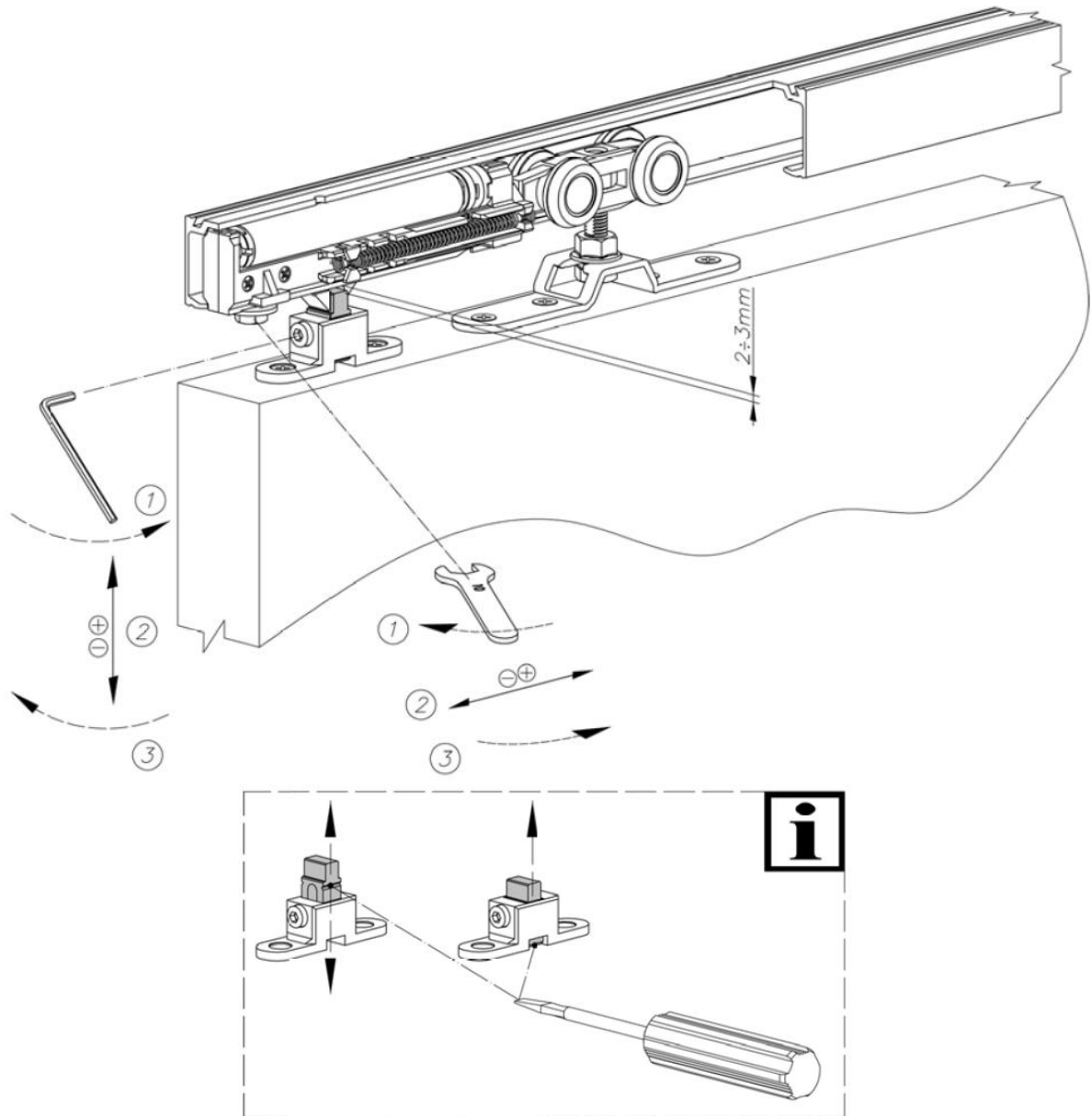



## Room Assembly

The principle of building all rooms follows the same guidelines. You will need to adapt the following steps according to the size of room and your exact chosen layout.

Ensure that before you start assembly you have chosen where window panels, doors and options such as lights and transfer hatches are to be located.

The room should be installed on a level non-shedding surface (such as vinyl). Minor imperfections in the floor can be taken up with the adjustment of the feet on all upright poles. Use a spirit level throughout to ensure the room is level and straight.

## WARNINGS



In order to assemble this room you must be fully competent in all tasks associated with assembly.

All personnel must be suitably trained in the use of any equipment used during the installation of this Cleanroom Kit. It is the customer's responsibility to ensure the safety of all colleagues and personnel carrying out this task. Monmouth Scientific Limited do not accept responsibility for any injury or damage howsoever caused.

Any electrical work necessary should be carried out by a qualified electrician.



If at any time, you are not comfortable with any aspect of the installation then STOP and seek professional assistance.

Monmouth Scientific can provide free-of-charge support on the telephone by calling +44 1278 458090 during normal office hours or will happily provide an installation service. Please contact us for a quotation if you wish to use the installation service.

# IF IN DOUBT ASK FOR HELP.



Start in a corner without a door. Add the lower bar **1** on each side of the corner post **B** to give immediate stability to the structure.



Start adding to the first two panels evenly and build up the corner panels to ensure and maximise stability in the structure from the start. Do not forget to add the vertical 8mm to 6mm plastic reducer strips **5** either side of a panel. It is advisable to add these as you go and not to fit in advance.

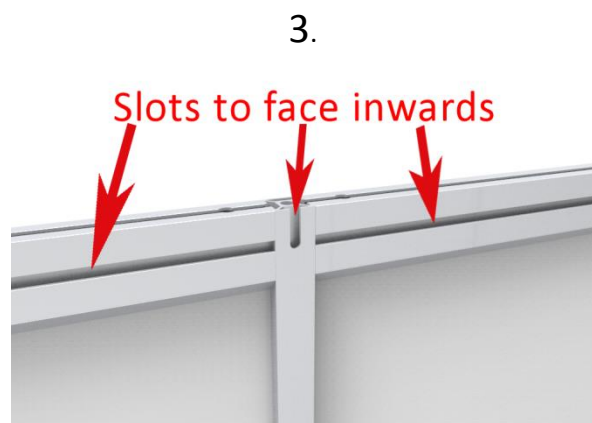

It is important that the slots at the top of the double faced profiles **9** used in the mid wall sections, and the slots on the top bars **3** are facing inwards. This will allow the ceiling bars to join to the main structure.

4.



Continue building the walls in an even construction until two panels are either side of the corner. Minor imperfections in the floor can be taken up with the adjustment of the feet on all upright poles.

Use a spirit level throughout to ensure the room is level and straight.

Ensure the room is square at all times. If it is not erected square, minor adjustments can be made during the construction, however you must take care not to stress any joints.

5.



Build to the first corner and add the first return panel. Add the ceiling cross members 15/17 and 20 using the internal vertical slots highlighted in step 3.

6.



Continue the build of the sides evenly adding ceiling cross members as you go. This will brace the structure from side to side.

7.



If you have an atrium (Plus models) do not forget to use the single faced upright ⑬ at this point to allow the internal walls to connect.







8.



Build the full internal wall (Plus models only) ensuring the door is in the right position. Please remember to install the sliding door header rails ⑳ and ㉑ in the appropriate positions above the door opening and immediately adjacent to the sliding door panel. Please ensure the additional slots on these pieces are on the side that the door is to be hung (generally outside of the cleanroom)

9.



Add in the ceiling tile support bars to the slots in the upper bars. Two 969.5mm  and two 919.5mm  angle bars are generally required per tile space (in some of the smaller rooms different size tiles are used and the 919.5mm bar  is to be substituted with ,  or . See drawings for layout.

Note: No tile bars are not fitted in a CAM location.

The outer structure is now complete. Ensure all unions have been fully tightened.

10.



Add the CAM unit(s) to the structure in the appropriate place along with the control panel – see section [Installing Clean Air Modules \(CAM\)](#) . THIS UNIT IS HEAVY – ENSURE ALL SAFETY PROCEDURES ARE FOLLOWED.

11.



Add the (optional) lights to the desired positions and plug into the distribution block and then connect to the CAM unit.

12.



Add in the ceiling tiles to all areas with support extrusions.  
Fit end caps ④ to the visible ends of the reinforced ceiling members ⑰.

13.



Mount the door rail(s) ⑳ and door(s) ㉑ to the room and fit the door rail cover(s) ㉒.

After calibration/set up of the CAM units, the room is then complete.

Prior to use as a cleanroom, all surfaces must be cleaned in accordance with the requirements of your application.

The room may now be validated if required prior to any usage. For UK based installations, Monmouth Scientific will be happy to quote for validation if not already selected. If you have already selected validation please contact us on 01278 458090 to arrange a convenient date.

## Installing Clean Air Modules (CAM)

Clean Air Modules are fitted into position in the correct spot on the ceiling. The modules will need the flange rails bolted on the sides prior to installation as these will stop the CAM falling through the hole in the ceiling!



The CAM units are HEAVY! We would recommend using suitable lifting equipment at all times when handling the CAM modules.

The fitting of any CAM unit is a two person (minimum) process. Suitable access equipment should be used and your own risk assessment should be undertaken when installing CAM modules. All personnel must be suitably trained in the use of any access or lifting equipment. It is the customer's responsibility to ensure the safety of all colleagues and personnel carrying out this task. Monmouth Scientific Limited do not accept responsibility for any injury or damage howsoever caused.

**YOU MUST NEVER LIFT, PUSH OR SUPPORT THE CAM UNIT ON THE FACE OF THE FILTER. THIS IS EXTREMELY DELICATE AND WILL DAMAGE THE FILTER AND ULTIMATELY THE EFFECTIVENESS OF YOUR CLEANROOM.**

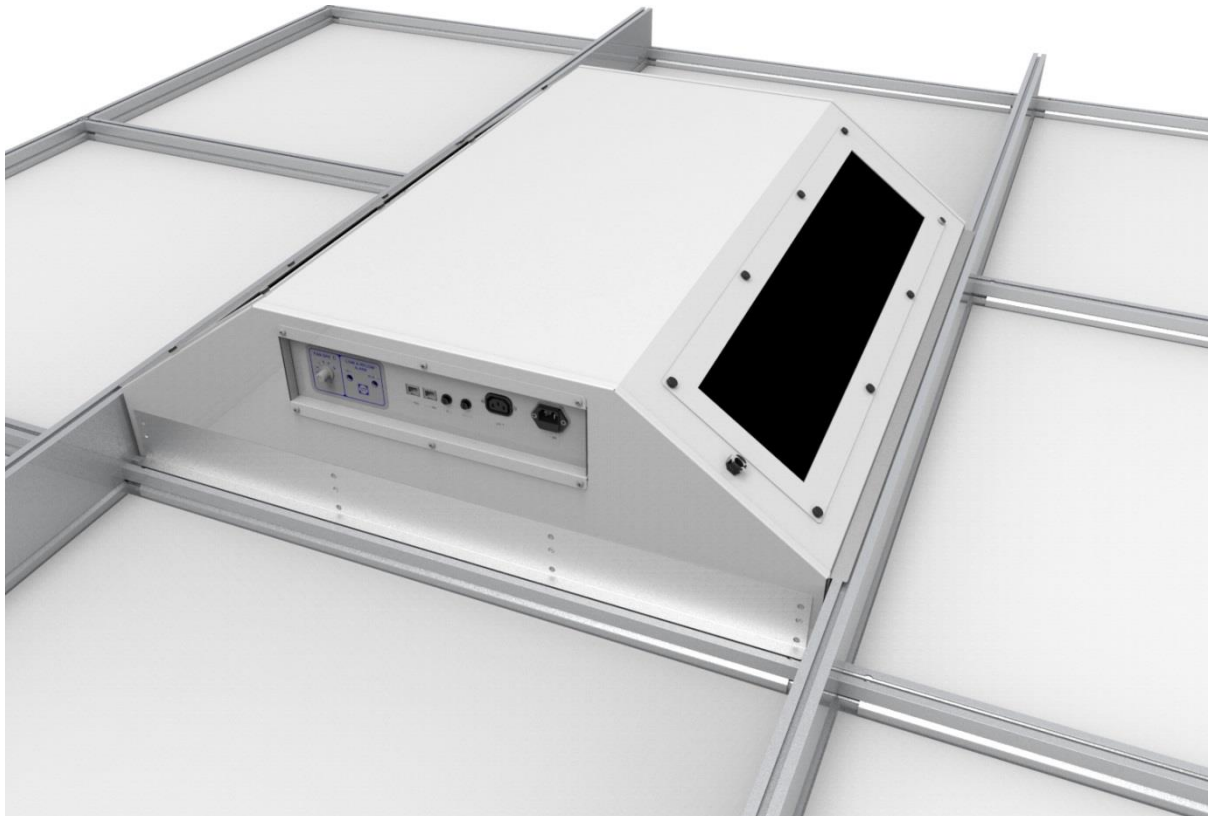

## CAM1000

### Introduction



**CAUTION: Weight approximately 40kg. Follow all correct lifting techniques. Use lifting equipment when handling.**

The CAM1000 units are self-contained filtration units designed to fit into the aluminium grid system with your cleanroom. On spans of 3m or more, they will sit in between the larger reinforced ceiling cross members.

They are designed to be used on their own, however if you do wish to connect two or more together then up to 4 units can be daisy-chained from the IEC socket mounted on the side of the unit. If not used to power a second CAM1000, then this socket can be used to power the lights in the room. This way they are all turned on and off by a single switch.

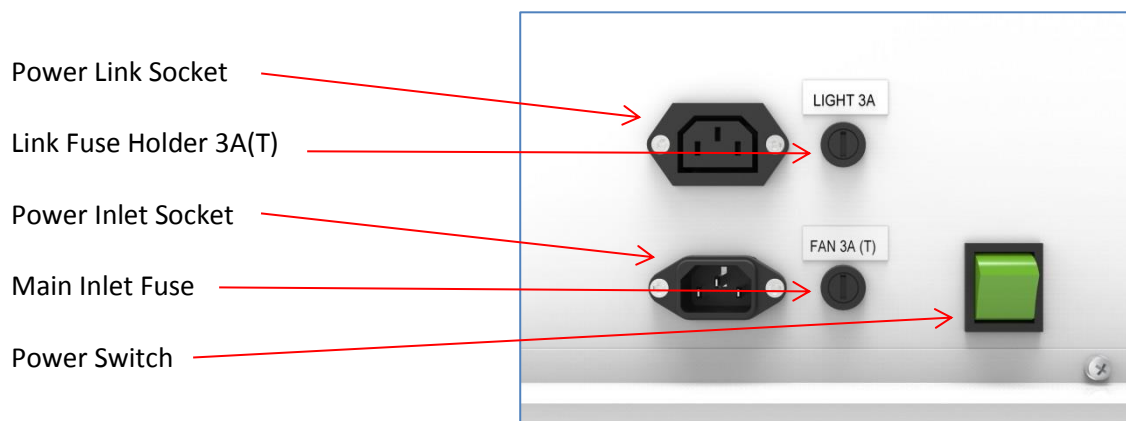

**IMPORTANT: The loading on the whole system MUST NOT exceed 3amps in total. If in doubt consult a qualified electrician.**



The power switch above is an inline switch that requires a power supply. All the CAM1000 units and/or lights subsequent to this will be fed from this switch.



## Installation

The control panel should be mounted at a convenient point near to the entrance of the cleanroom. It is fixed to the aluminium frame using the provided self-drilling screws. To access the mounting points, open the flaps either side of the panel to find suitable holes.

Do not fix to the door itself, nor anywhere within the pathway/travel of the door.

To mount the CAM1000 itself, please first put safety first. The CAM1000 needs to be lifted to ceiling height and we strongly recommend the use of suitable lifting equipment.

Before fitting, ensure the hole is a suitable size. The hole should measure 970mm x 665mm.



The side rails are already fitted to the CAM1000 as per the picture above.

The CAM unit must be handled very carefully. If it is dragged on/or hit by the aluminium frame, damage may be caused to the HEPA filter or paintwork of the CAM. If the CAM is dropped, please return to Monmouth for checking prior to installation. If the unit is damaged, Monmouth accepts no responsibility and repair/replacement will be chargeable.

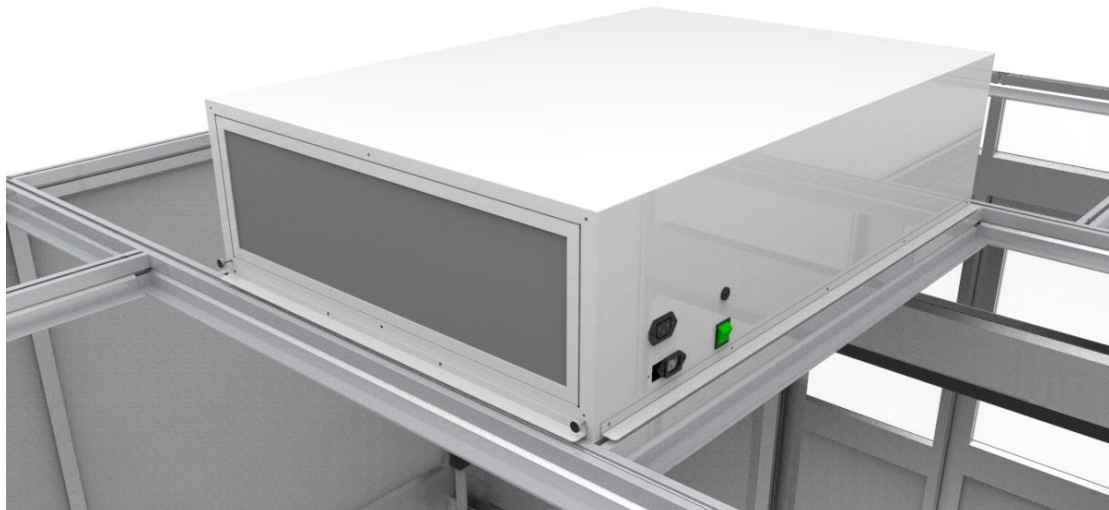

## Setting the fan speed

To accurately set the fan speed this requires the use of a calibrated Ø100mm rotating vane anemometer with readings taken from 150mm from filter face.



Turn the system on and set the fan speed using the speed control knob (located next to main HEPA filter outlet and DOP test port – under cover cap). Set to the required level using the anemometer to measure the air velocity from the HEPA filter.

The air volume required to achieve N air changes per hour can be calculated by the following formula:

$$\text{Air volume required (m}^3\text{/hour)} = \text{Room Volume (m}^3\text{)} \times N$$

The air volume through the module can be calculated by the following formula:

$$\text{CAM1000 : Air Volume (m}^3\text{/hour)} = 0.37 \text{ (filter area in m}^2\text{)} \times \text{measured HEPA velocity (m/sec.)} \times 3600 \text{ (secs/hr)}$$

Based on the filter size used in this module (610mm x 610mm), the following table gives an indication of air volume (m<sup>3</sup>/hour) against HEPA velocity:

HEPA Velocity (m/sec.)	Air Volume (m <sup>3</sup> /hour)
0.30	400
0.35	470
0.40	535
0.45	600
0.50	670
0.55	736
0.60	800
0.65	870
0.70	935
0.75	1000
0.80	1075
0.85	1130

If you do not have an anemometer, then you will need to judge the position of speed control knob as follows:

Knob position	Approx. Air Volume (m <sup>3</sup> /hour)
0	0
¼ Turn	275
½ Turn	550
¾ Turn	825
Full Turn (Maximum)	1100

## Maintenance

### Changing the pre-filters

Regular checks should be carried out to ensure the airflow performance is maintained. Should the module fail to achieve adequate performance, this normally indicates that the Pre-Filter/s and / or HEPA filter require changing.

(For replacement filter part numbers, see page 5)

1. Turn the system off and disconnect from mains.
2. Remove the screws securing the pre-filter retaining frame.
3. Remove the pre-filter frame and filter.
4. Replace pre-filter with the correct type (see page 5).
5. Replace the screws securing the pre-filter retaining frame.
6. Reconnect the mains supply and switch on.
7. Check the airflow and adjust if necessary (as detailed in the setup section)

### Changing the HEPA filter

1. Turn the system off and disconnect from mains.
2. Remove the screws securing the filter retaining frame.
3. Remove the filter frame, cover filter (if fitted) and HEPA filter.
4. Replace HEPA filter with the correct type (see page 5).
5. Replace cover filter and filter frame using the screws.
6. Reconnect the mains supply and switch on.
7. Check the airflow and adjust if necessary (as detailed in the setup section)
8. Filter should be DOP tested to verify filter integrity and results recorded.

### CAM1000 Replacement Filter Part Numbers

Replacement filters are available from Monmouth Scientific:

Pre-Filter	Part No-	PF-0081
HEPA – filter	Part No-	HF-0127

## CAM2250

### Introduction



**CAUTION: Weight approximately 50kg. Follow all correct lifting techniques. Use lifting equipment when handling.**

The CAM2250 units are self-contained filtration units designed to fit into the aluminium grid system with your cleanroom. On spans of 3m or more, they will sit in between the larger reinforced ceiling cross members.

If you have one module, it is designed to link to the control panel (below) by means of an RG45 control cable (5m cable provided). If you have two modules then the first links to the control panel and the second links to the first. Subsequent modules can be added later should requirements change (maximum of 8 units permissible).

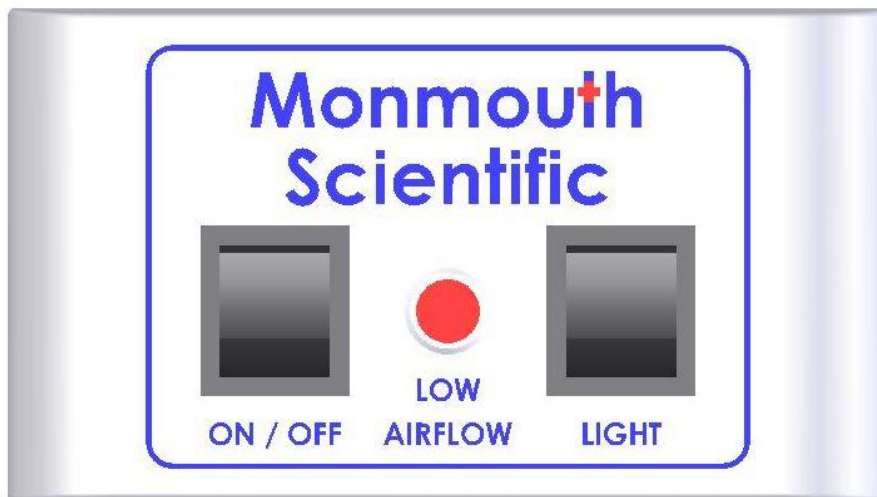

Each module is fitted with an electronic airflow monitor, which provides a visual warning on the control panel should the airflow drop below a pre-set level.

Each module requires a 230vac 13A electrical supply.

No power supply is required to the control panel.

An IEC outlet socket is provided for connecting up to 4 fluorescent or LED light fittings.

## Installation

The control panel should be mounted at a convenient point near to the entrance of the cleanroom. It is fixed to the aluminium frame using the provided self-drilling screws. To access the mounting points, open the flaps either side of the panel to find suitable holes.

Do not fix to the door itself, nor anywhere within the pathway/travel of the door.

To mount the CAM2250 itself, please first put safety first. The CAM2250 needs to be lifted to ceiling height and we strongly recommend the use of suitable lifting equipment.

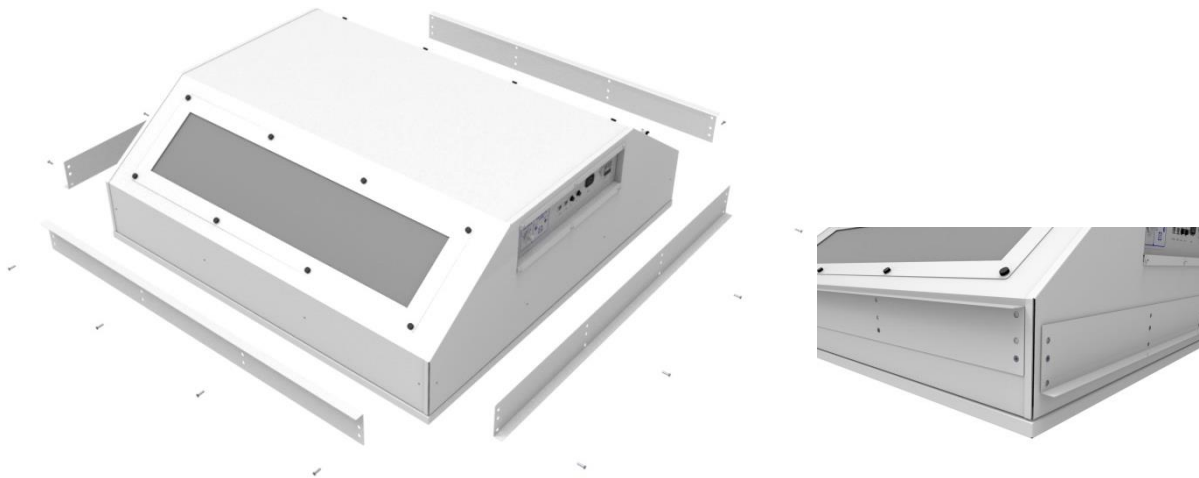

Fit the four side rails to the CAM2250 as per the picture above. You will notice that two rails are positioned higher than the others – this facilitates all round support when fitting over the 100mm high reinforced ceiling members below:

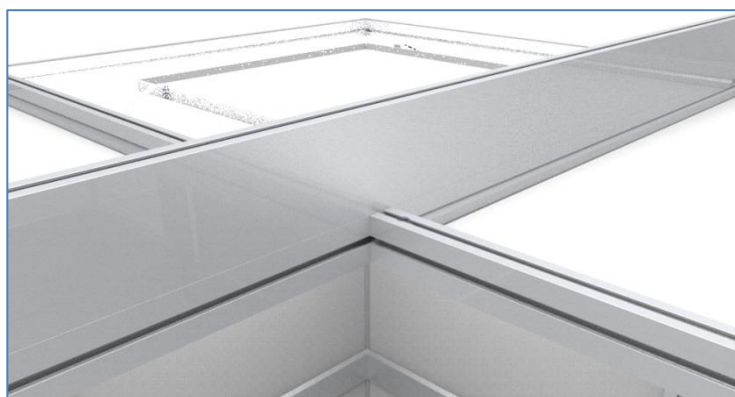

The CAM unit must be handled very carefully. If it is dragged or hit by the aluminium frame, damage may be caused to the HEPA filter or paintwork of the CAM. If the CAM is dropped, please return to Monmouth for checking prior to installation. If the unit is dropped, Monmouth accept no responsibility and damage will be chargeable.

## System Set-up

### CAM Module Connections

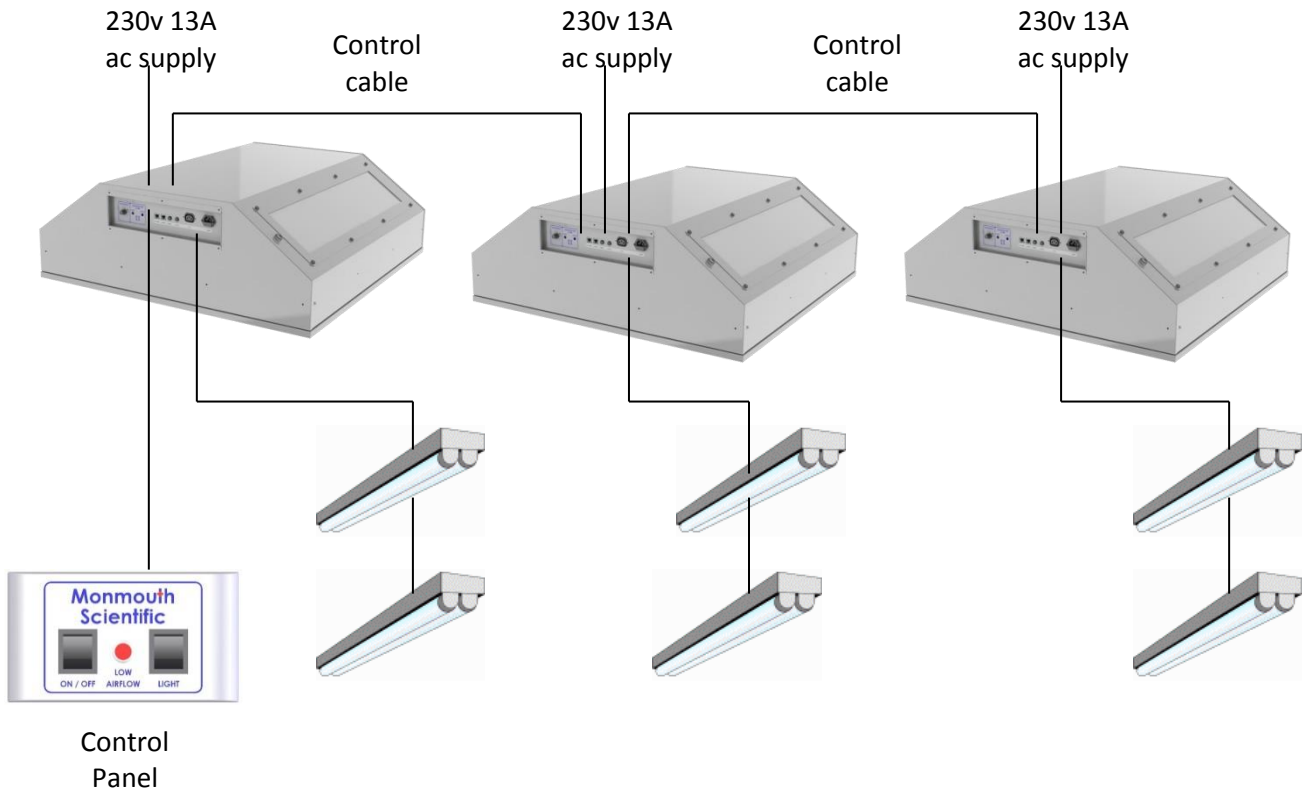

## Setting the fan speed

Once the room is room is complete, you will need to set the fan speed of the unit.

To perform accurately this requires the use of a calibrated Ø100mm rotating vane anemometer.

Turn the system on and set the fan speed to the required level on each CAM using a vane anemometer to measure the air velocity from the HEPA filter.

The air volume required to achieve N air changes per hour can be calculated by the following formula:

$$\text{Air volume required (m}^3\text{/hour)} = \text{Room Volume (m}^3\text{)} \times N$$

The air volume of each CAM can be calculated by the following formula:

$$\text{Air Volume (m}^3\text{/hour)} = 3000 \times \text{measured HEPA velocity (m/sec.)}$$

The following table gives an indication of air volume (m<sup>3</sup>/hour) against HEPA velocity:

HEPA Velocity (m/sec.)	Air Volume (m <sup>3</sup> /hour)
0.30	900
0.35	1050
0.40	1200
0.45	1350
0.50	1500
0.55	1650
0.60	1800
0.65	1950
0.70	2100
0.75	2250

As a rough guide when an anemometer is not available (and when pre-filters are new), you can use the 'Fan Speed' knob to set the speed as follows:

Fan Speed Position	Air Volume (m <sup>3</sup> /hour)
1	225
2	450
3	675
4	900
5	1125
6	1350
7	1575
8	1800
9	2025
10	2250



### Calibration of the low-airflow alarm

1. When the normal running fan speed has been set, note the position on the speed control knob.
2. Reduce the speed to the required alarm level
3. Press and hold the Alarm Mute button for 10 seconds until single 'beep' is heard. Release the button. 3 'beeps' will sound indicating the alarm point has been stored.
4. Reset the fan speed to the original level.
5. Check operation of the low airflow alarm by reducing the speed to the alarm level. The alarm should sound and the warning light should come on.
6. Reset the fan speed to the original set point and repeat the procedure with all other modules if fitted.

## Maintenance

### Changing the pre-filters

If the airflow monitoring system indicates a low airflow this normally indicates that the Pre-Filter/s require changing

8. Turn the system off
9. Remove the thumb screws securing each of the pre-filter retaining frames.
10. Withdraw the filters and fit a replacements
11. Replace the retaining frame and re start the system

### Replacement filter part numbers

Replacement filters are available from Monmouth Scientific:

Pre-Filters Part No:	PF-0033	2 off per unit
HEPA filter Part No:	HF-0043	1 off per unit



**Colour Coded Aluminium Framework – without panels**

**4M – 2m x 2m room**

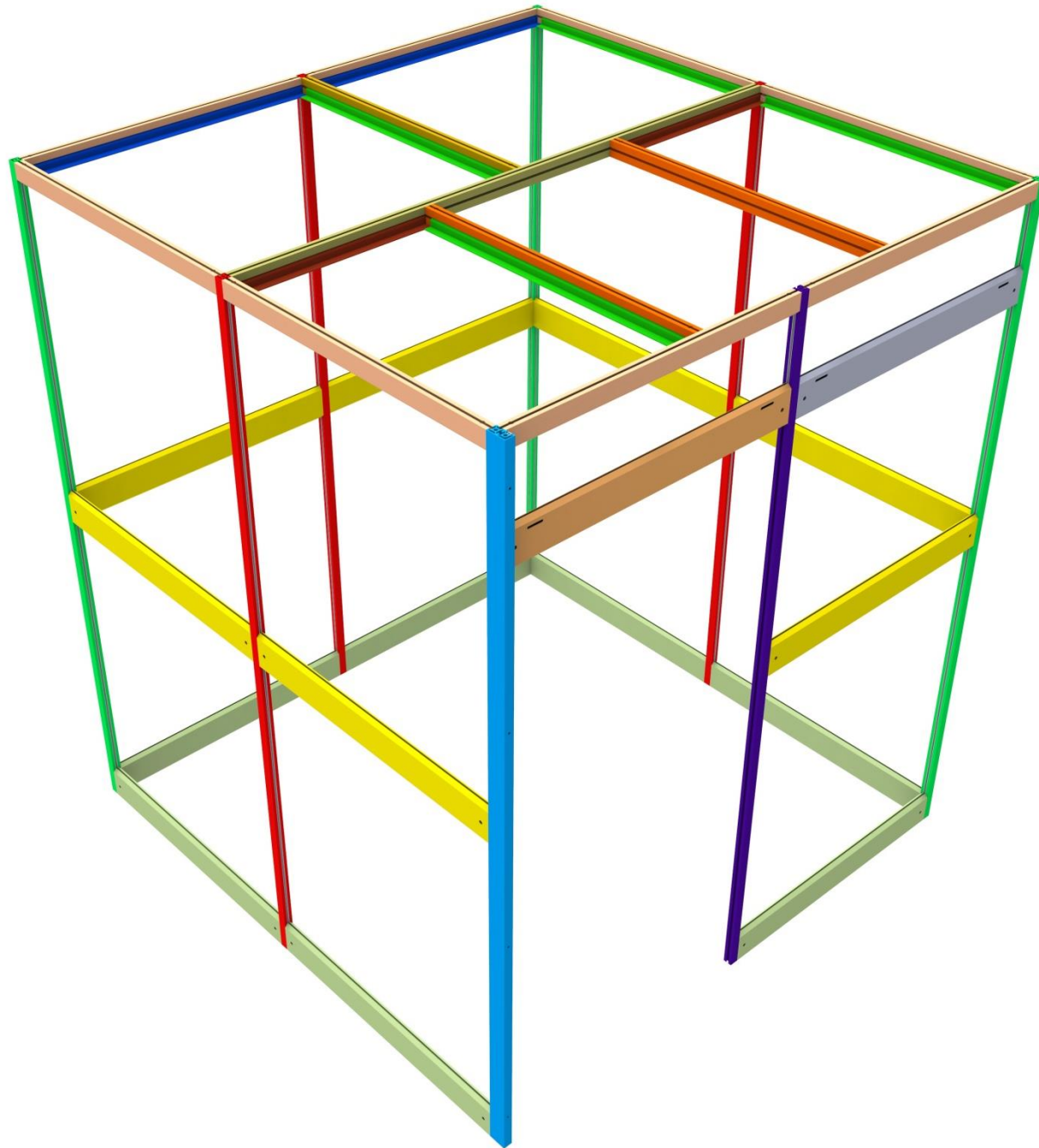



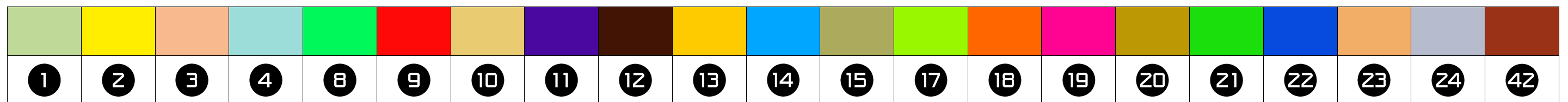
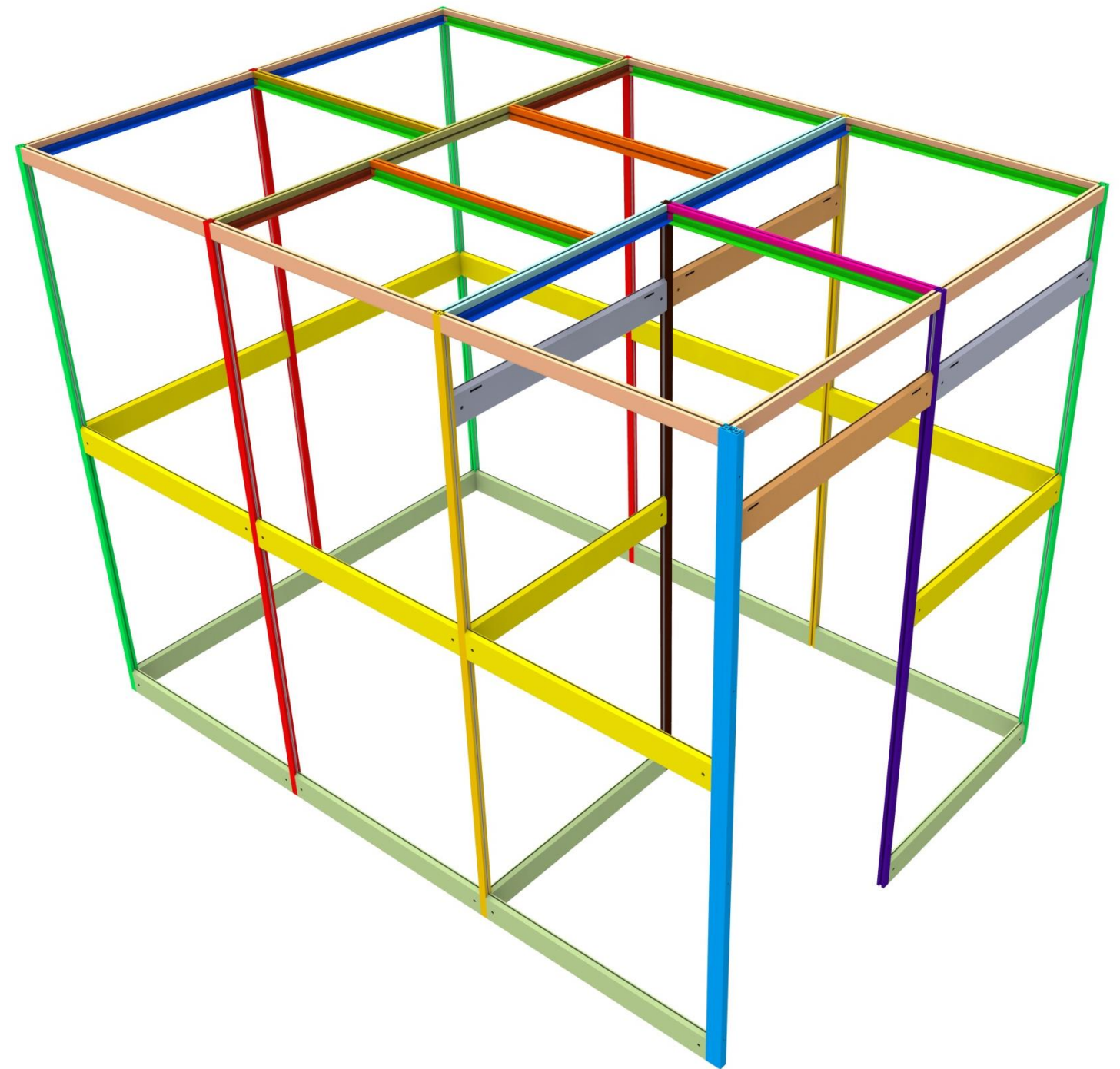



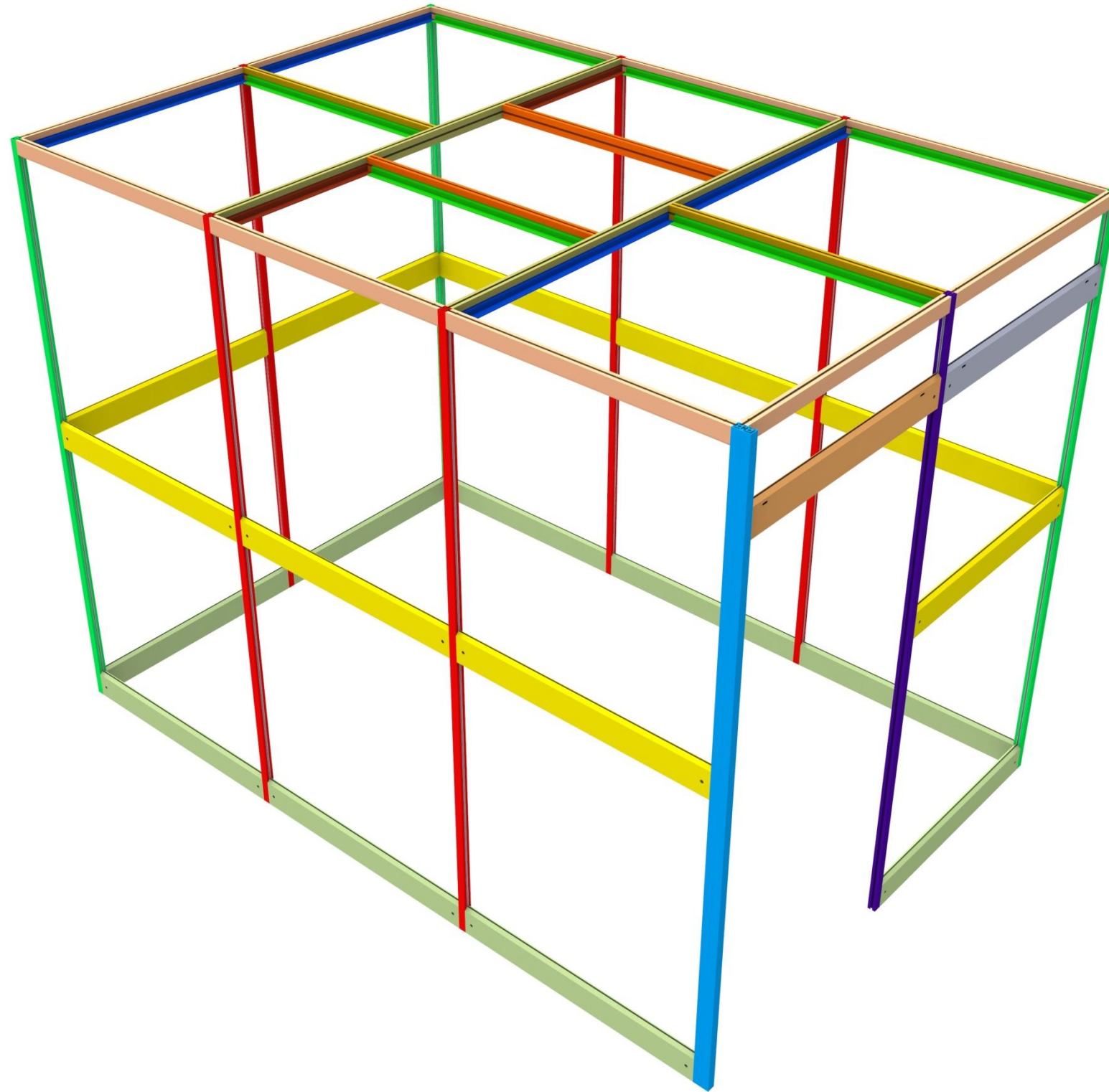





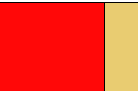
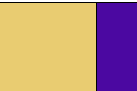

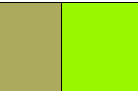

**4Mplus – 2m x 2m room with 1m x 2m atrium**

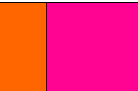
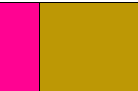
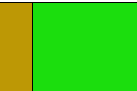

6M - 3m x 2m room



																				
1	2	3	4	8	9	10	11	12	13	14	15	17	18	19	20	21	22	23	24	42

6Mplus - 3m x 2m room with 1m x 2m atrium

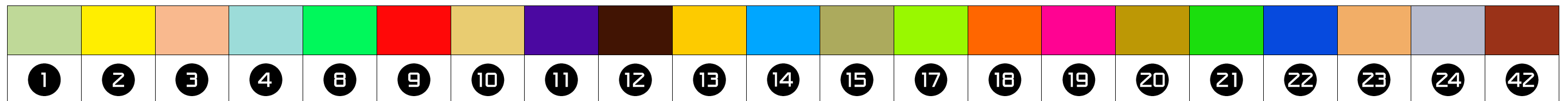
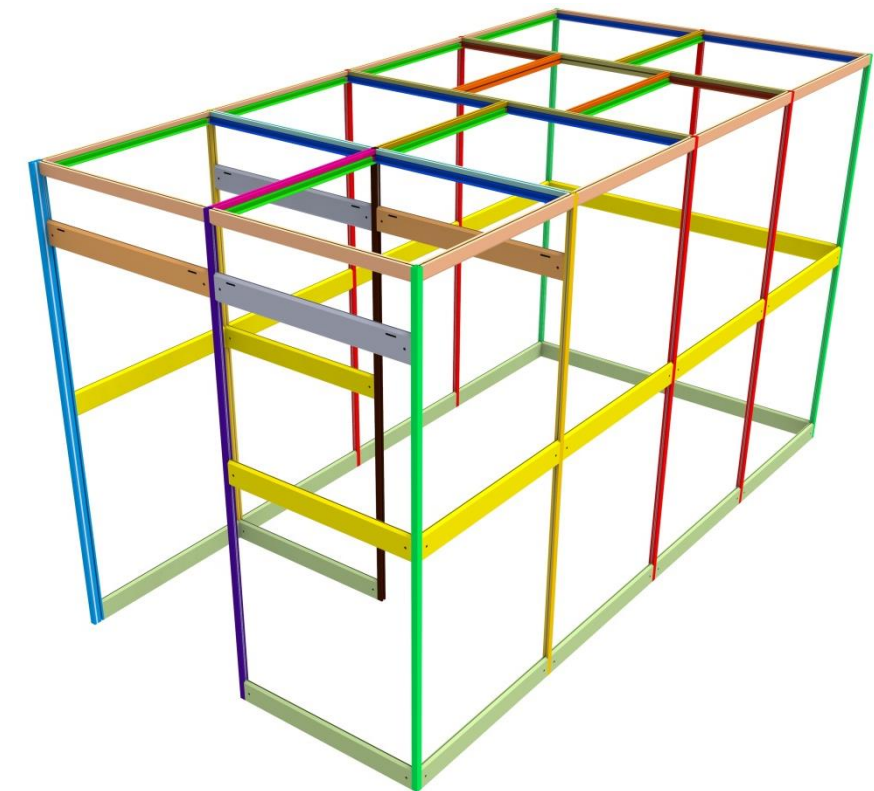
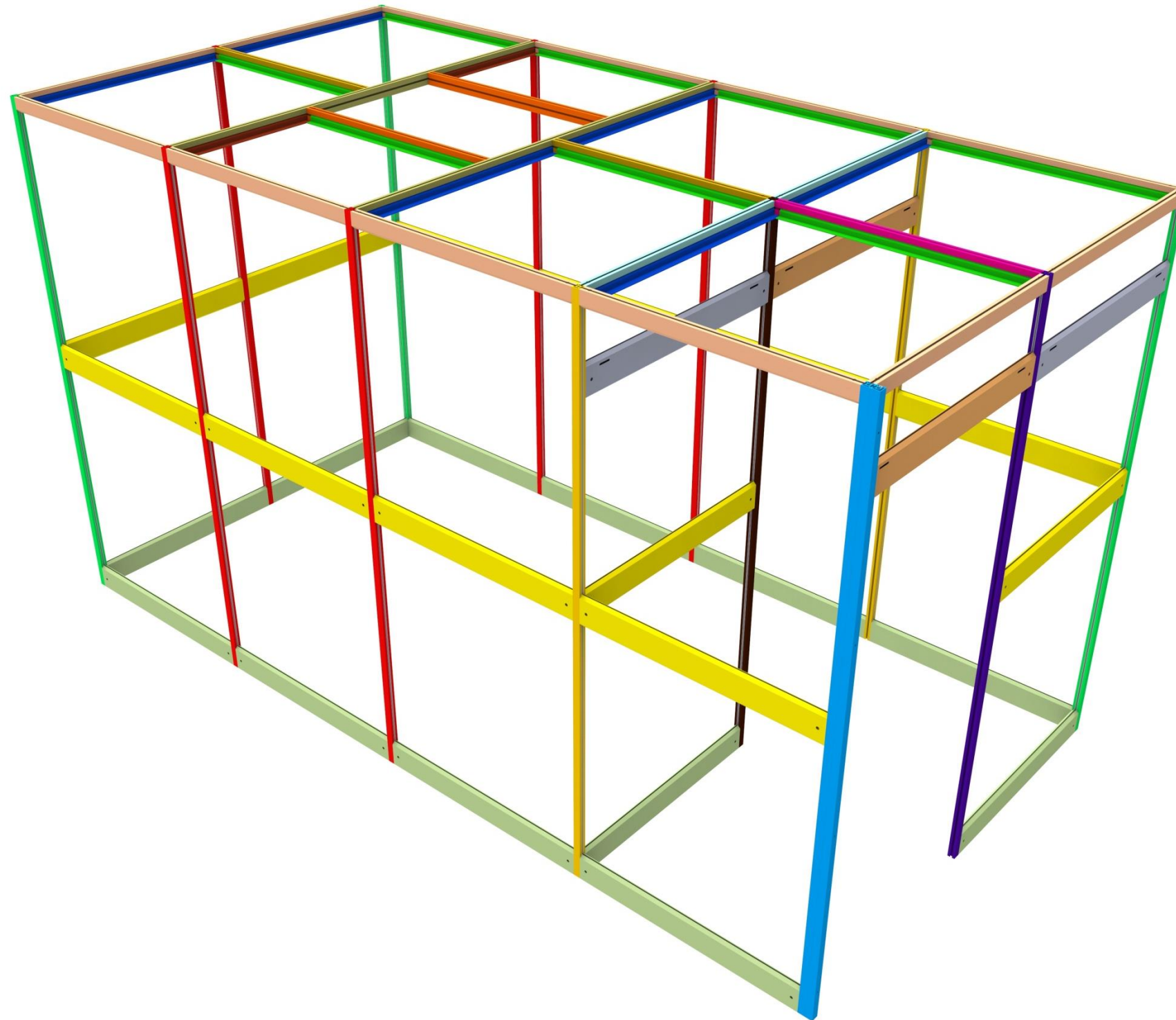

9M - 3m x 3m room

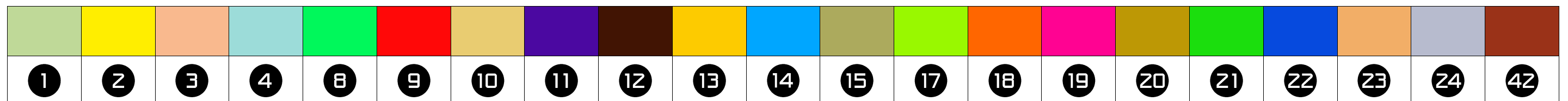
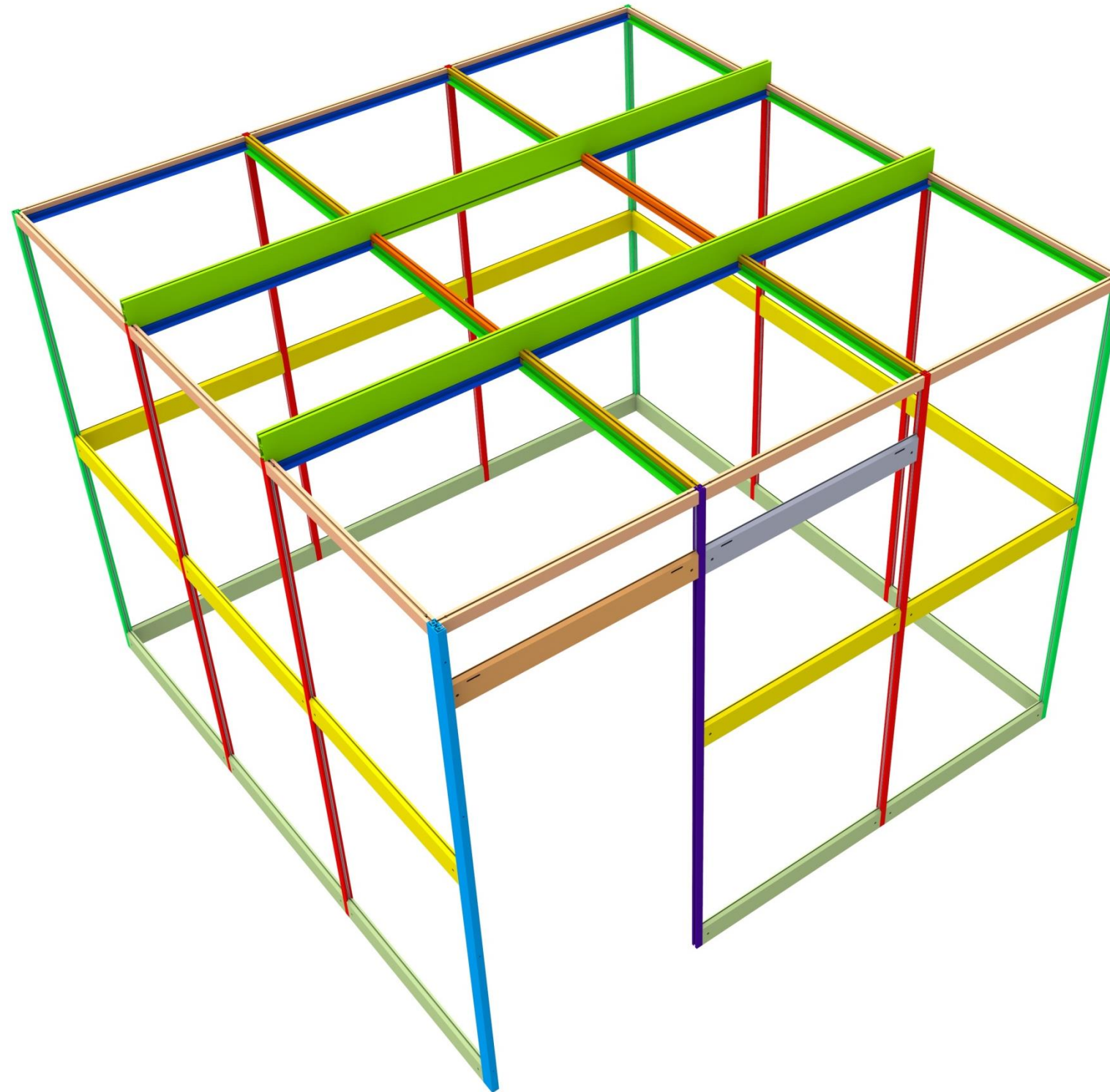

9Mplus - 3m x 3m room with 1m x 3m atrium

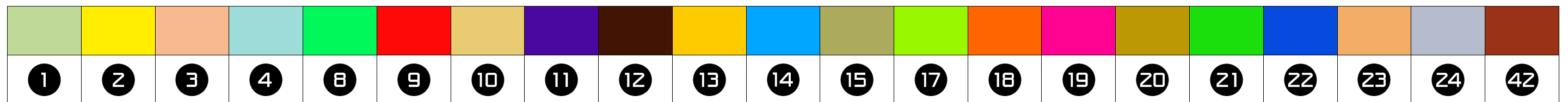
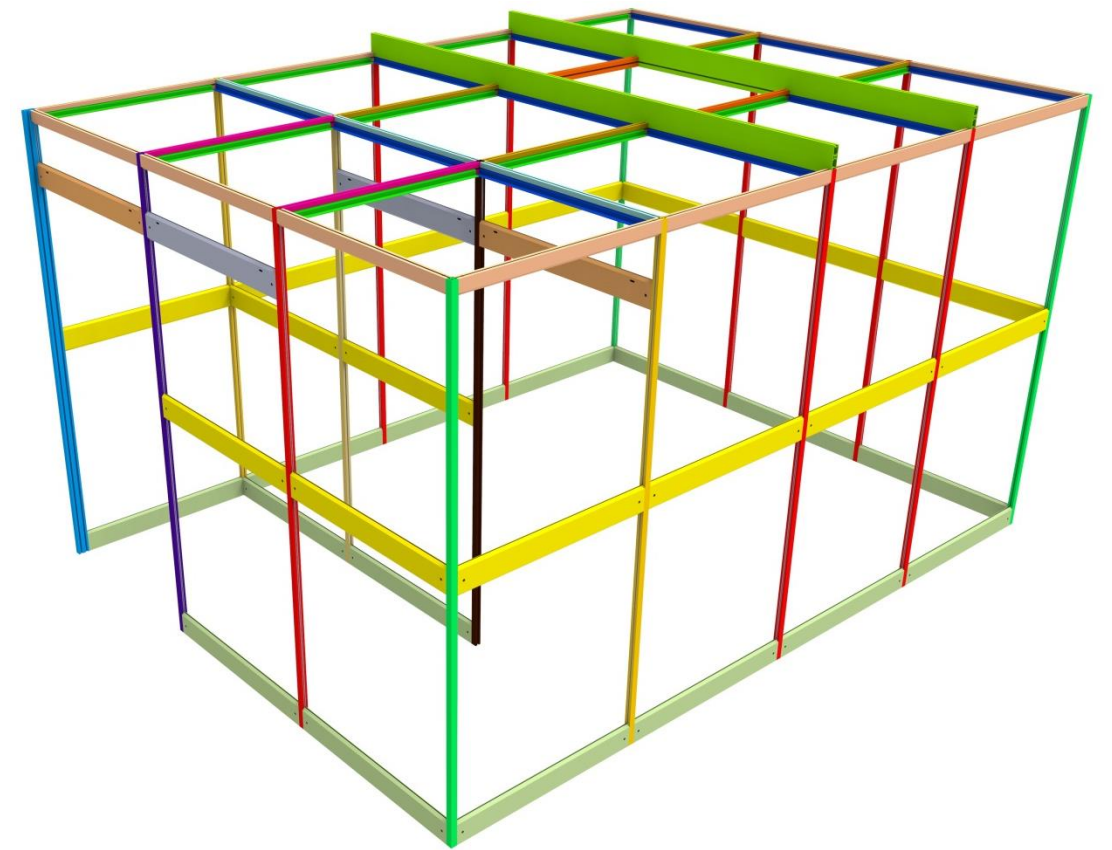
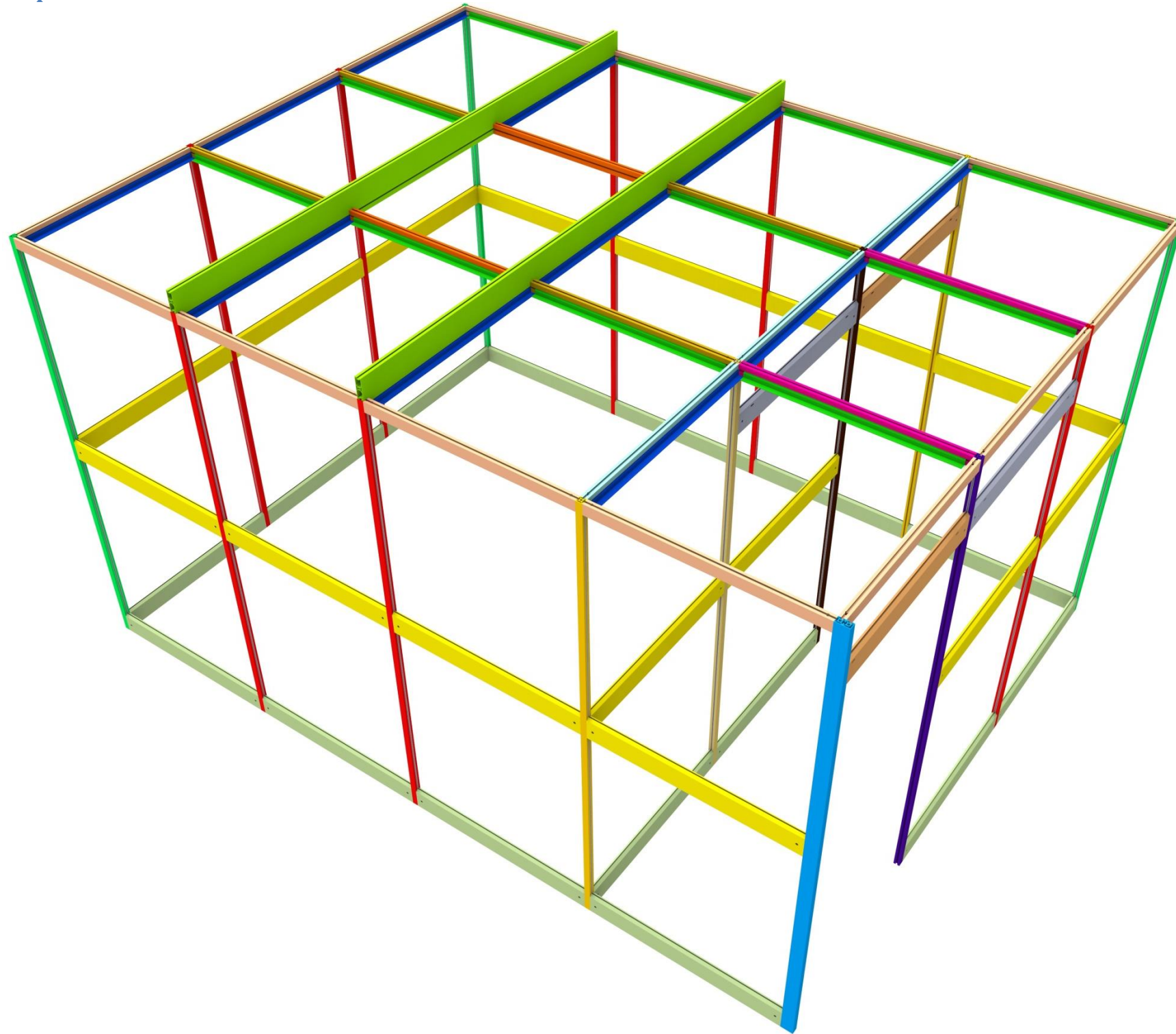

12M - 4m x 3m room

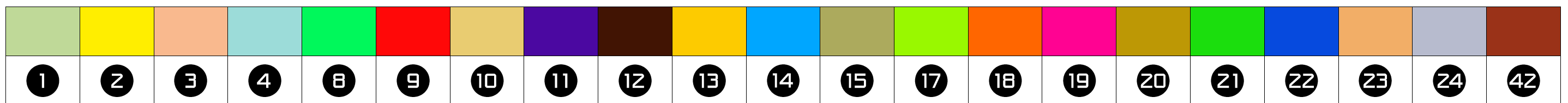
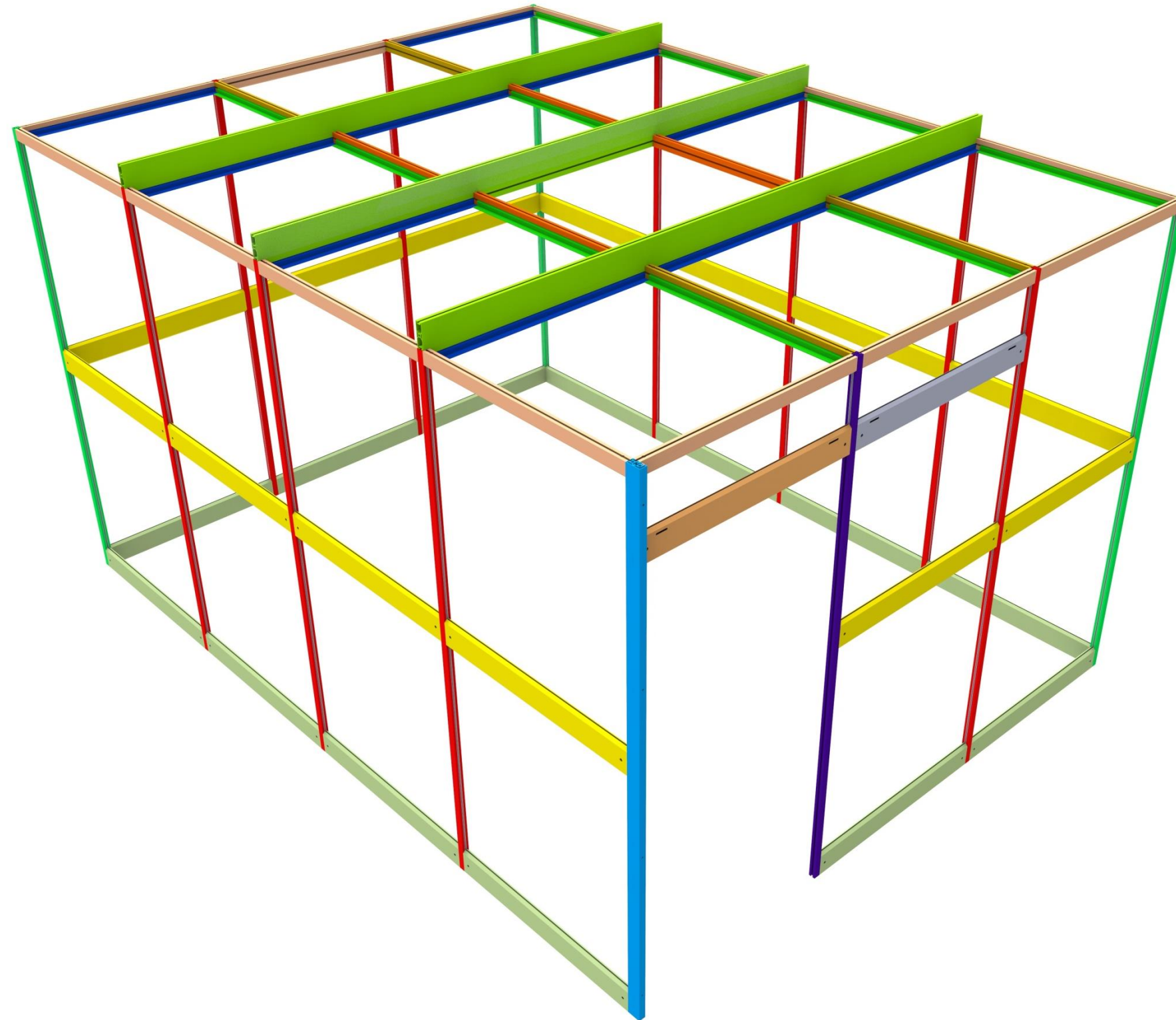

12Mplus - 4m x 3m room with 1m x 3m atrium

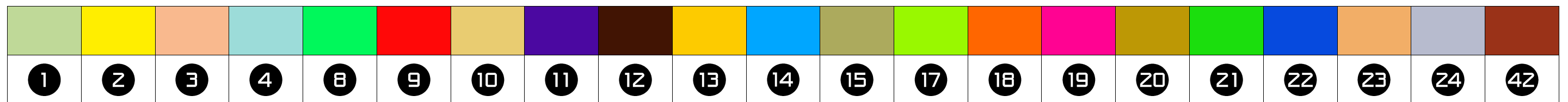
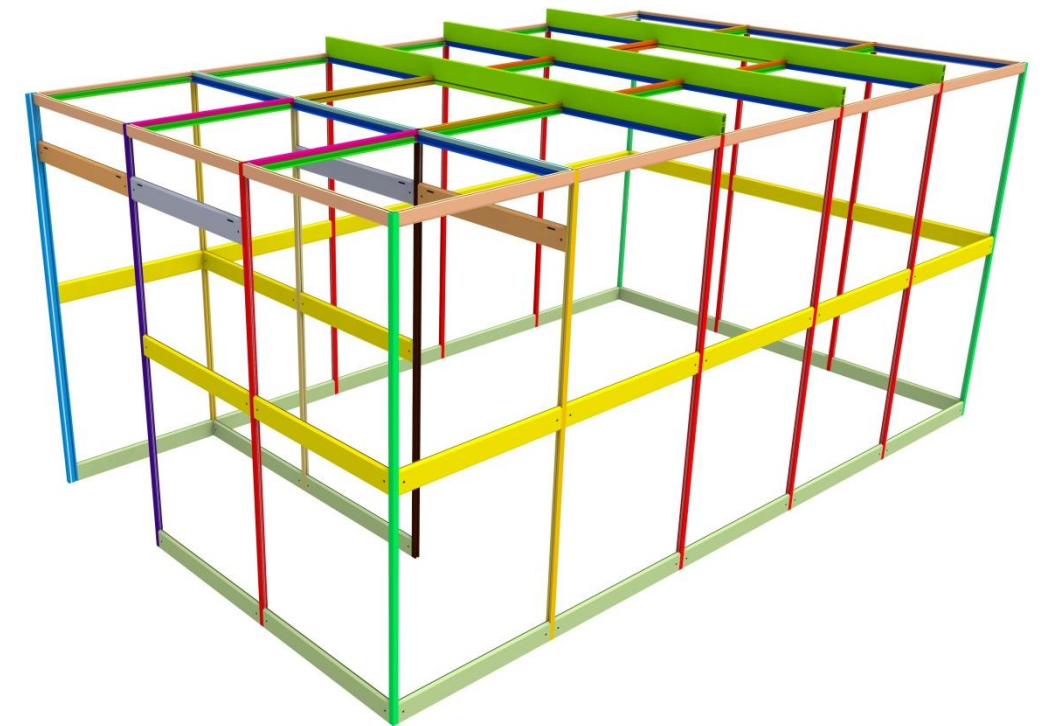
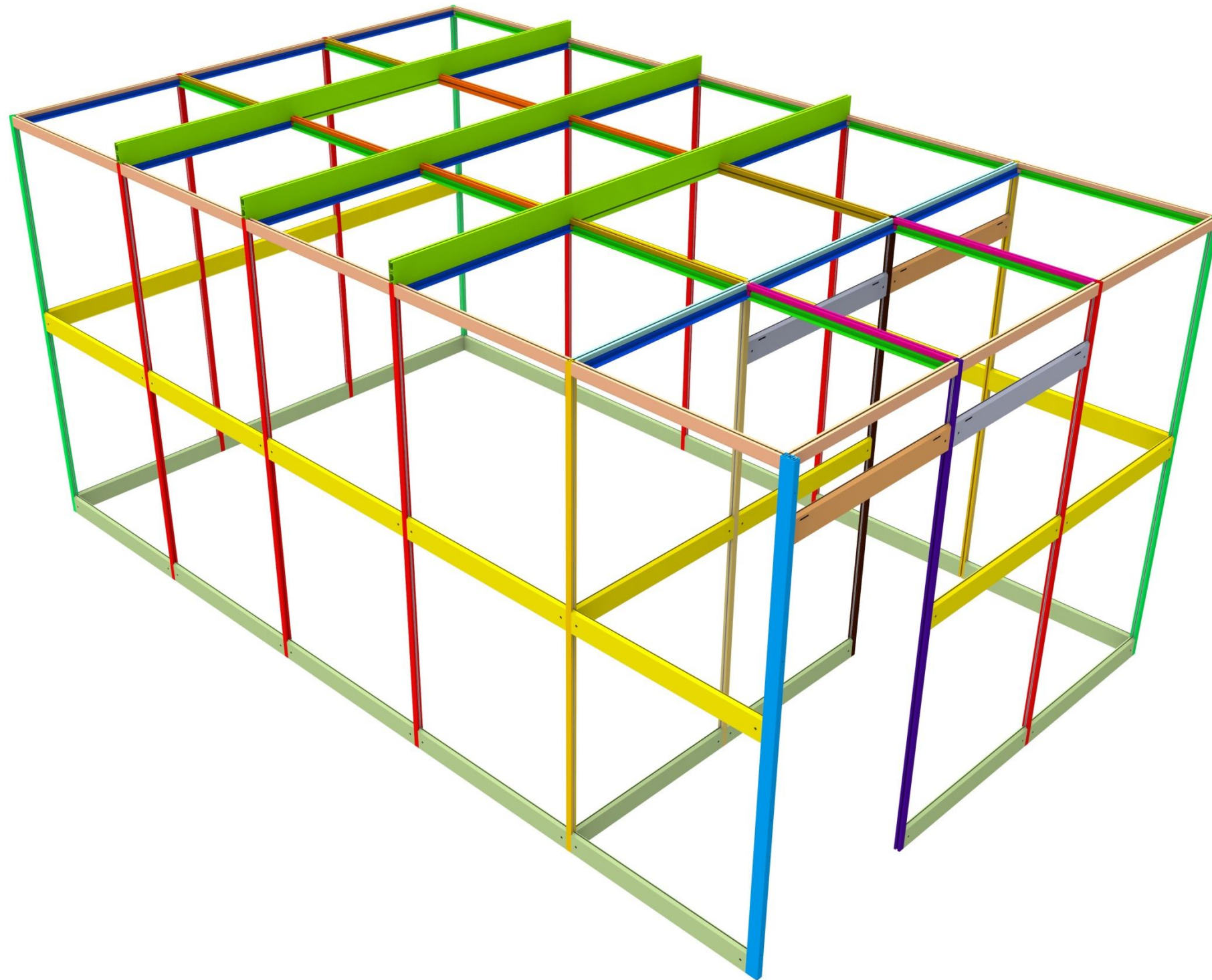

**Complete Cleanroom Layouts -**

**4M - 2m x 2m room**

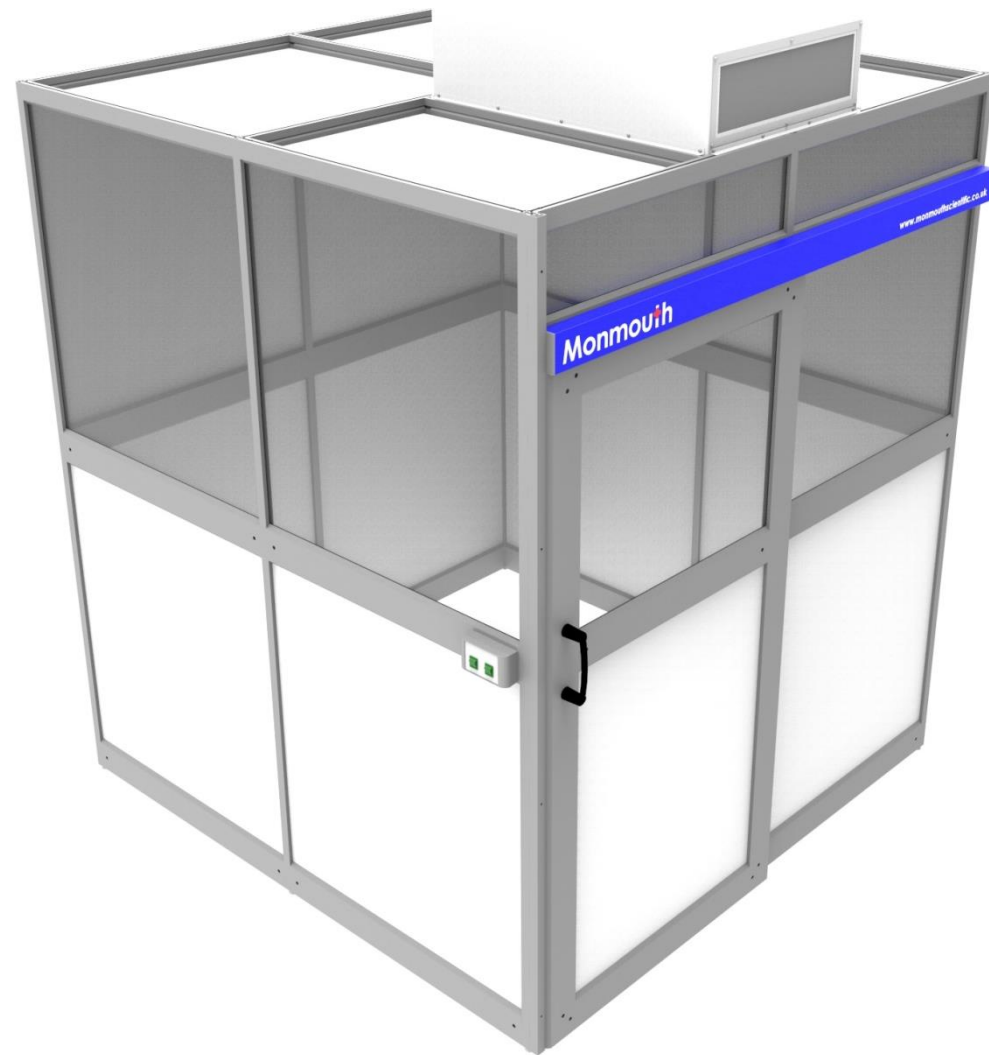

**4Mplus - 2m x 2m room with 1m x 2m atrium**

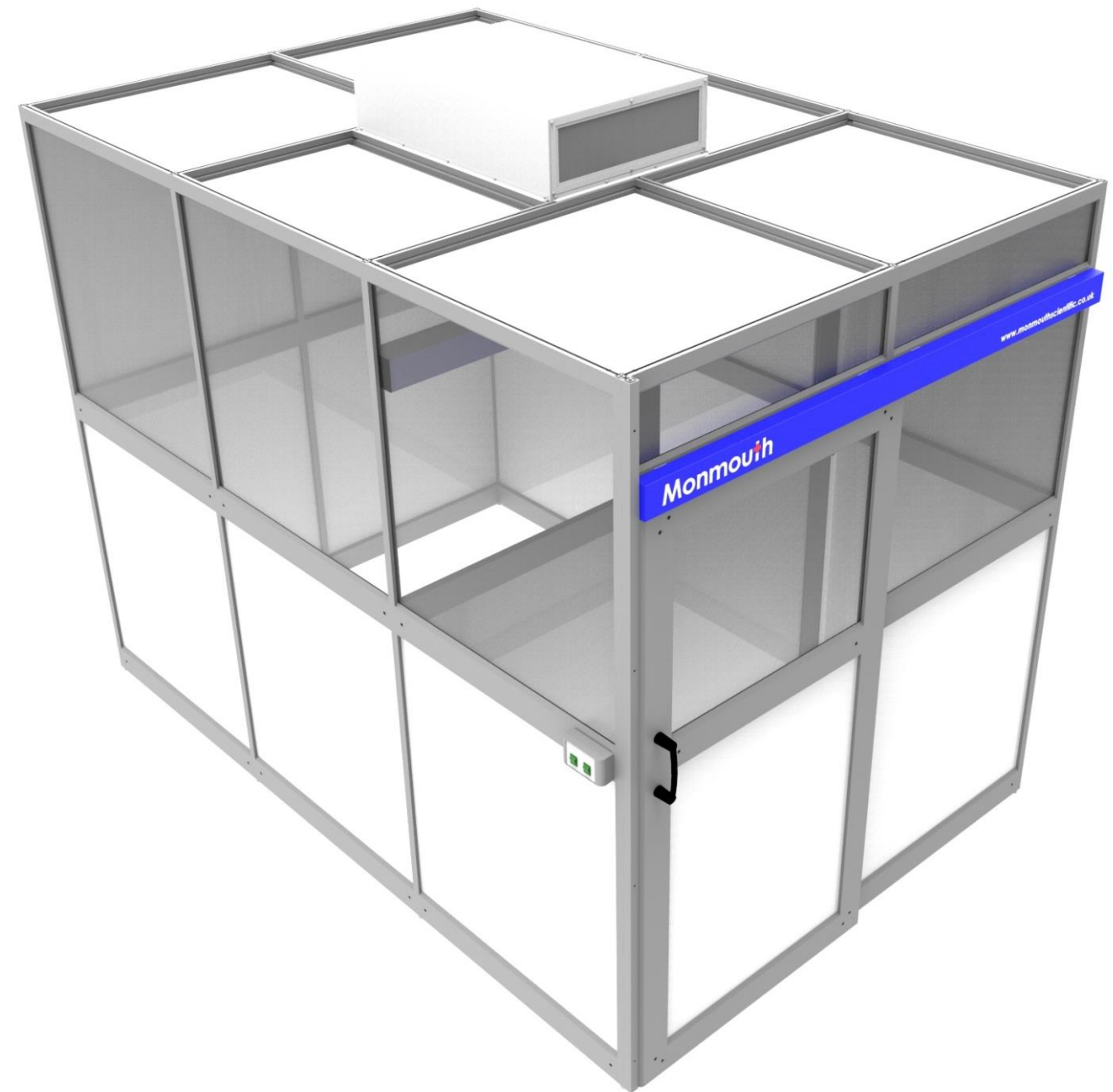



6M - 3m x 2m room

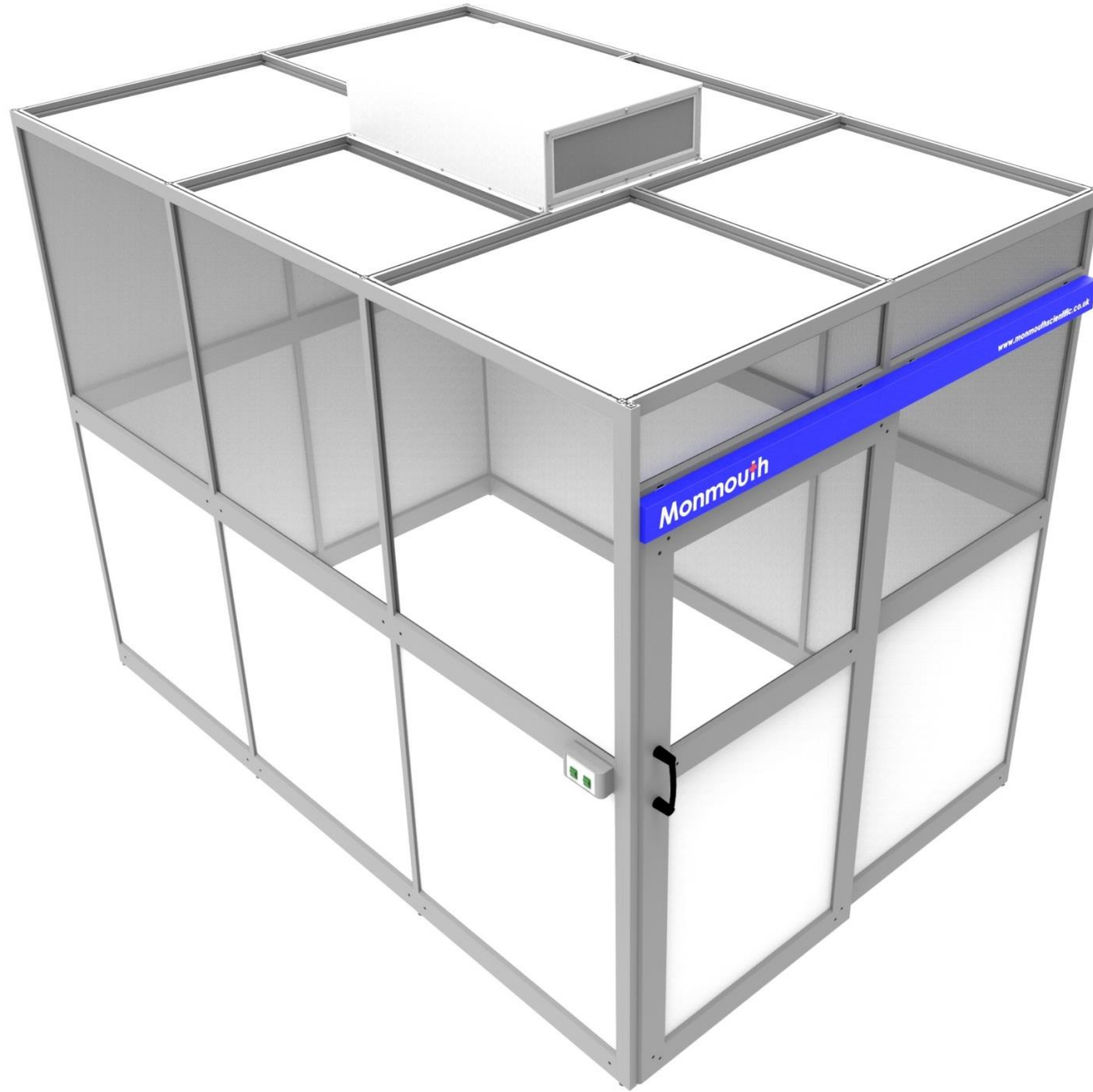

6Mplus – 3m x 2m room with 1m x 2m atrium

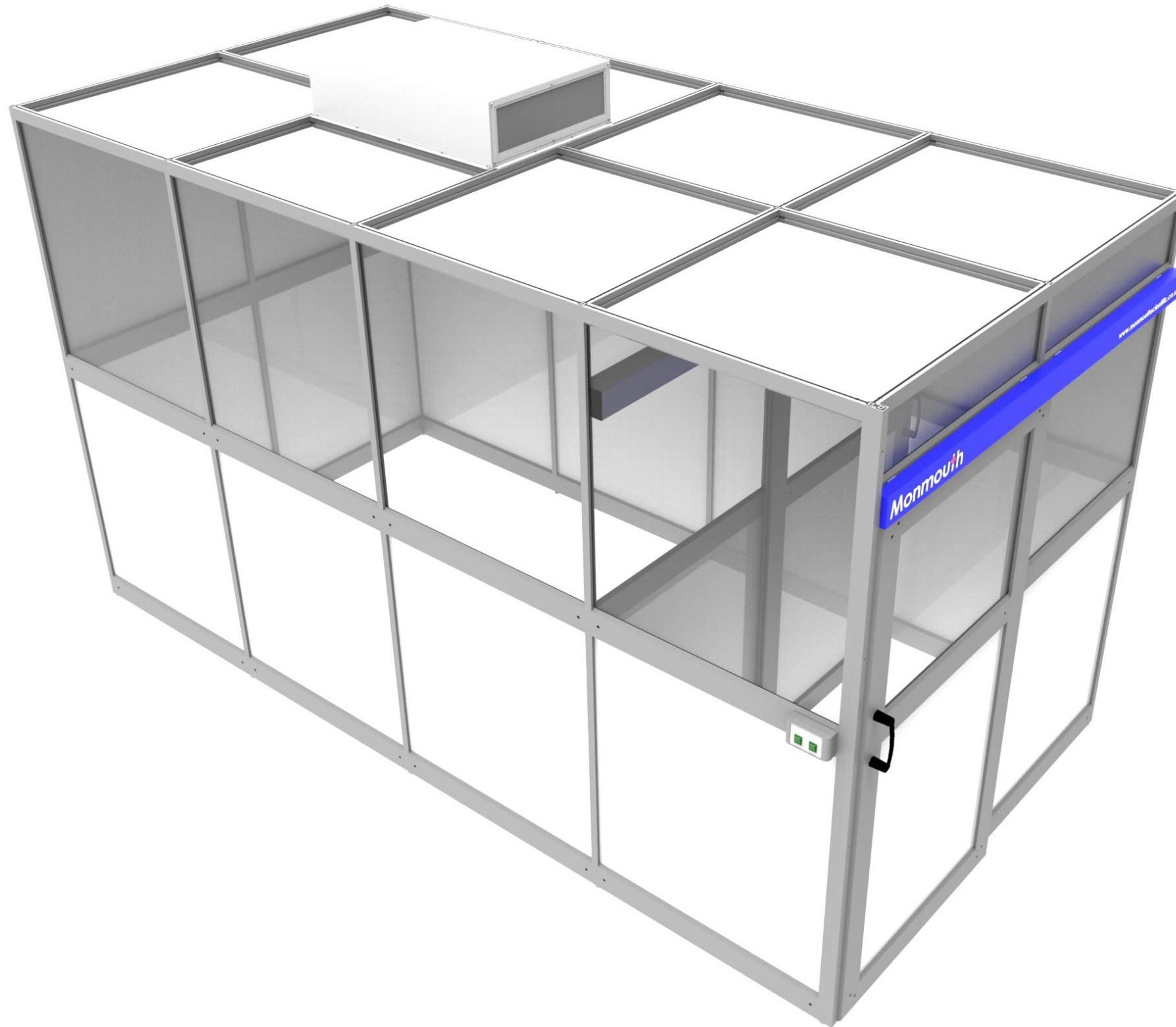

9M – 3m x 3m room

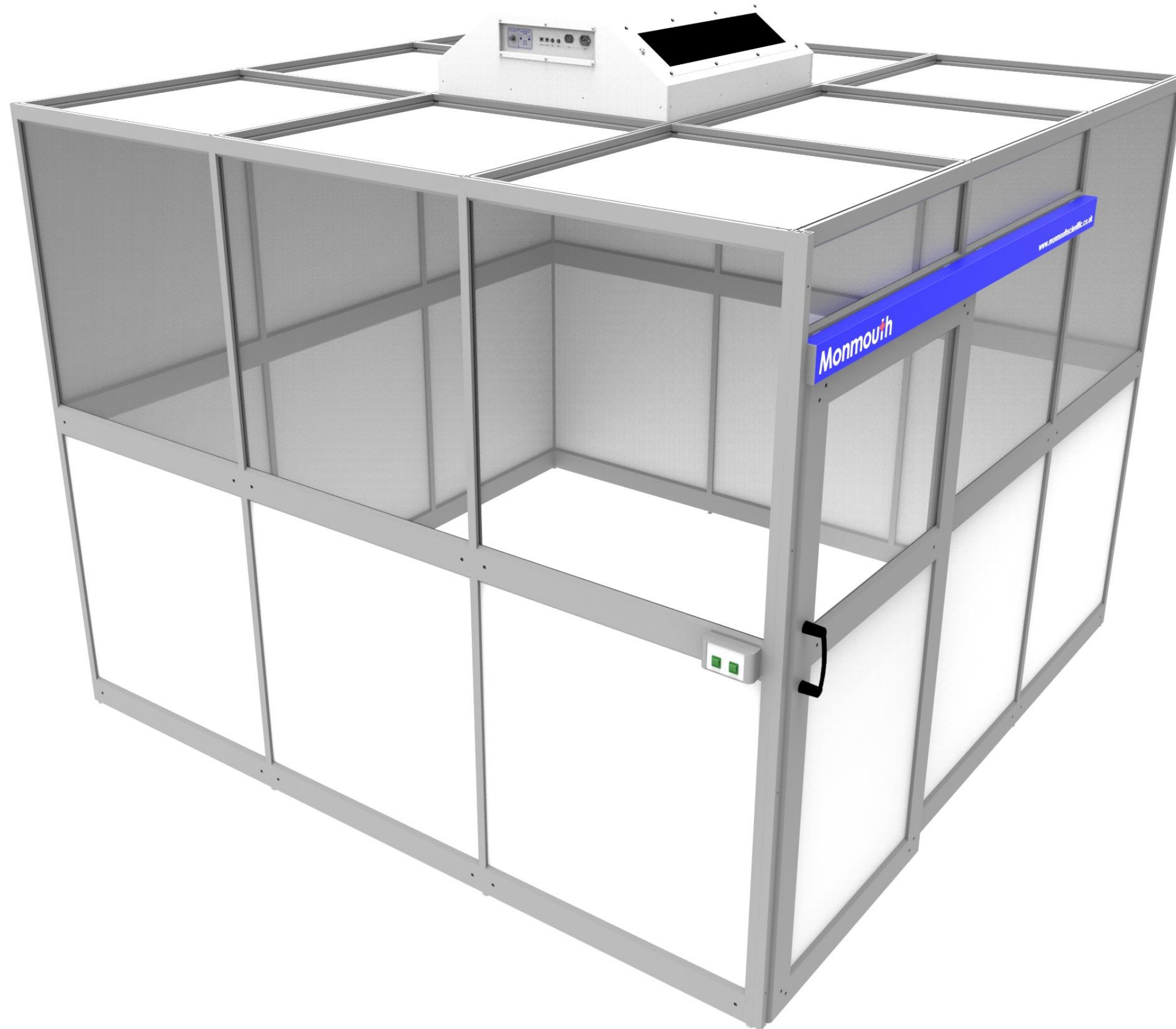

9Mplus – 3m x 3m room with 1m x 3m atrium

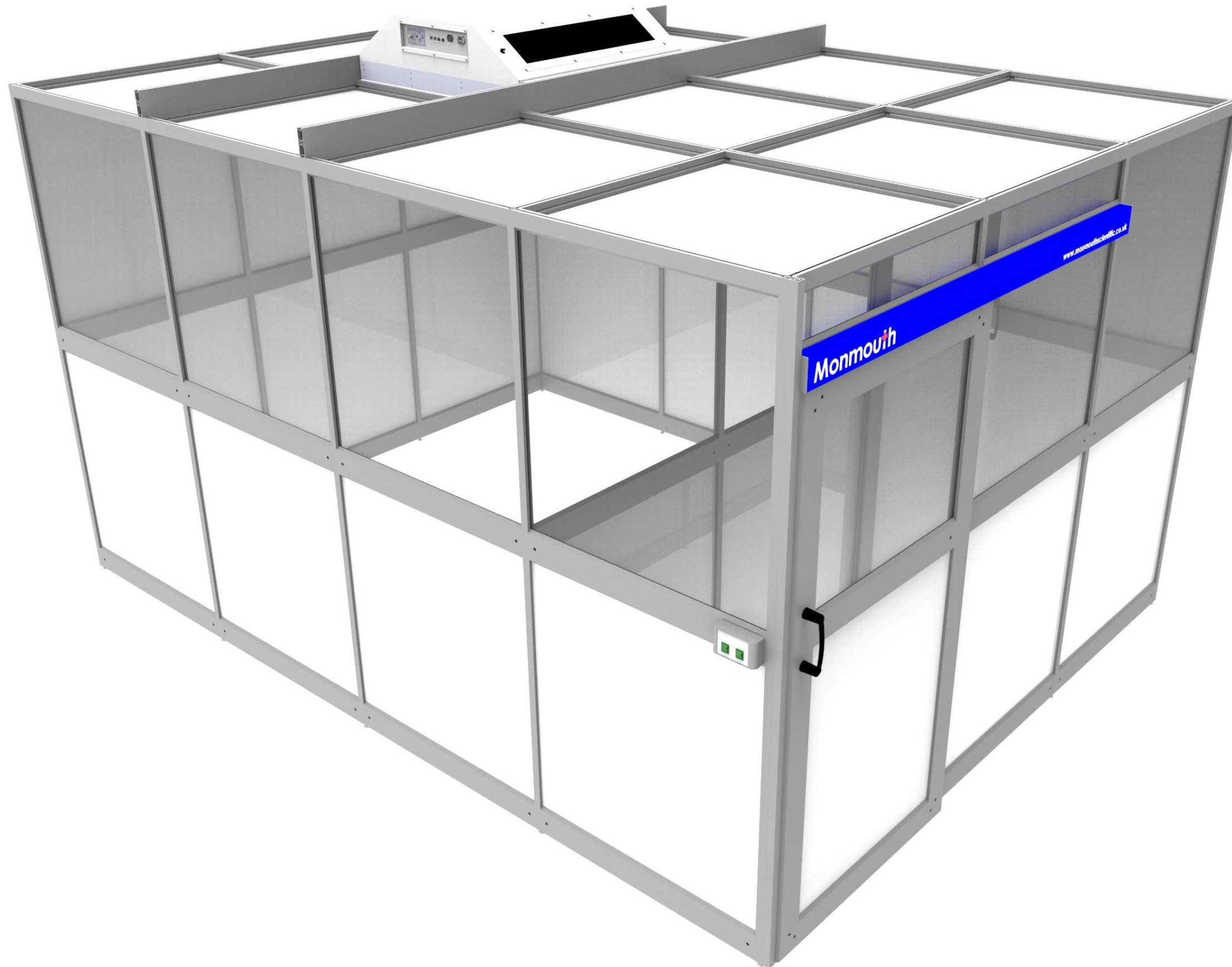

12M - 4m x 3m room

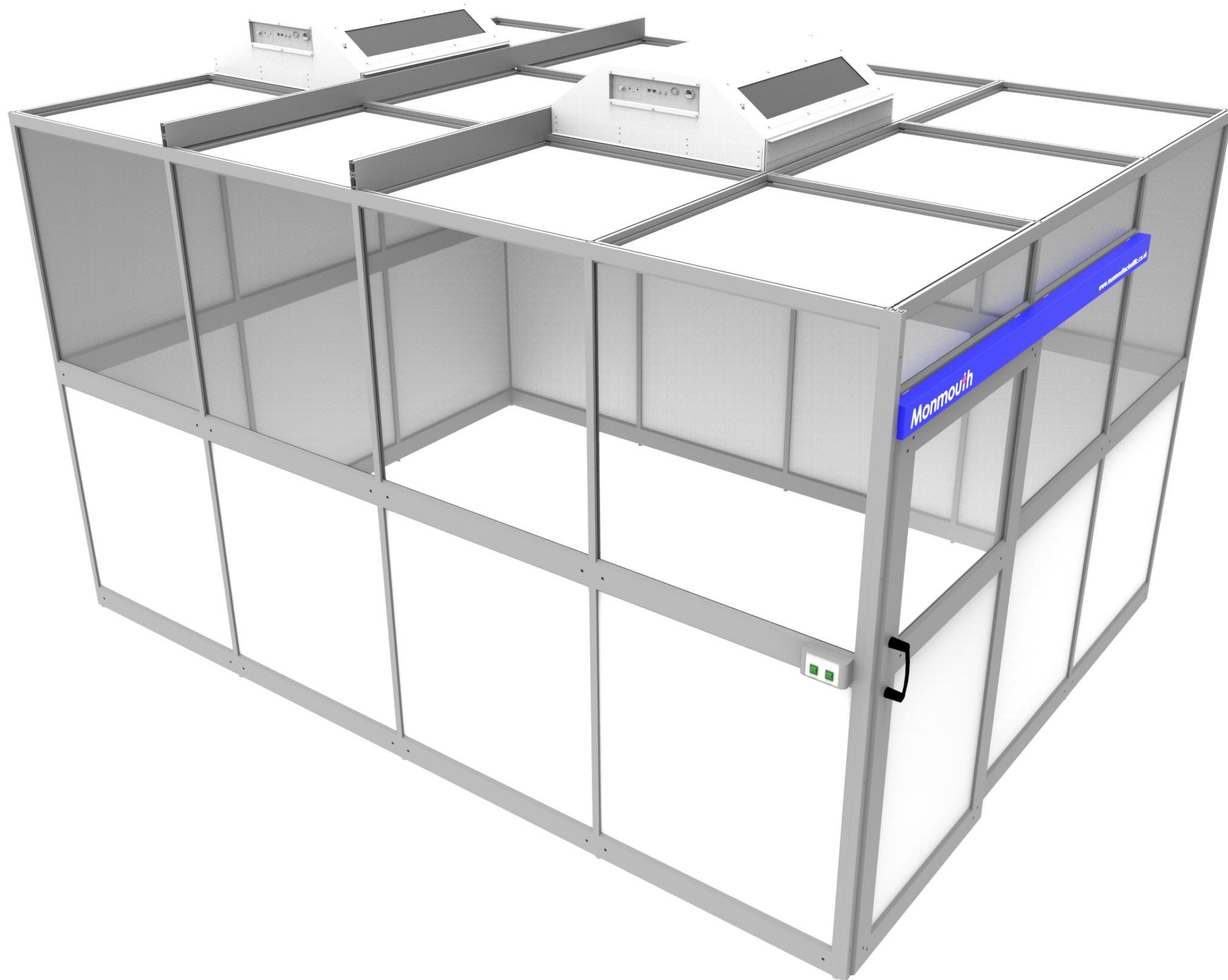

12Mplus - 4m x 3m room with 1m x 3m atrium

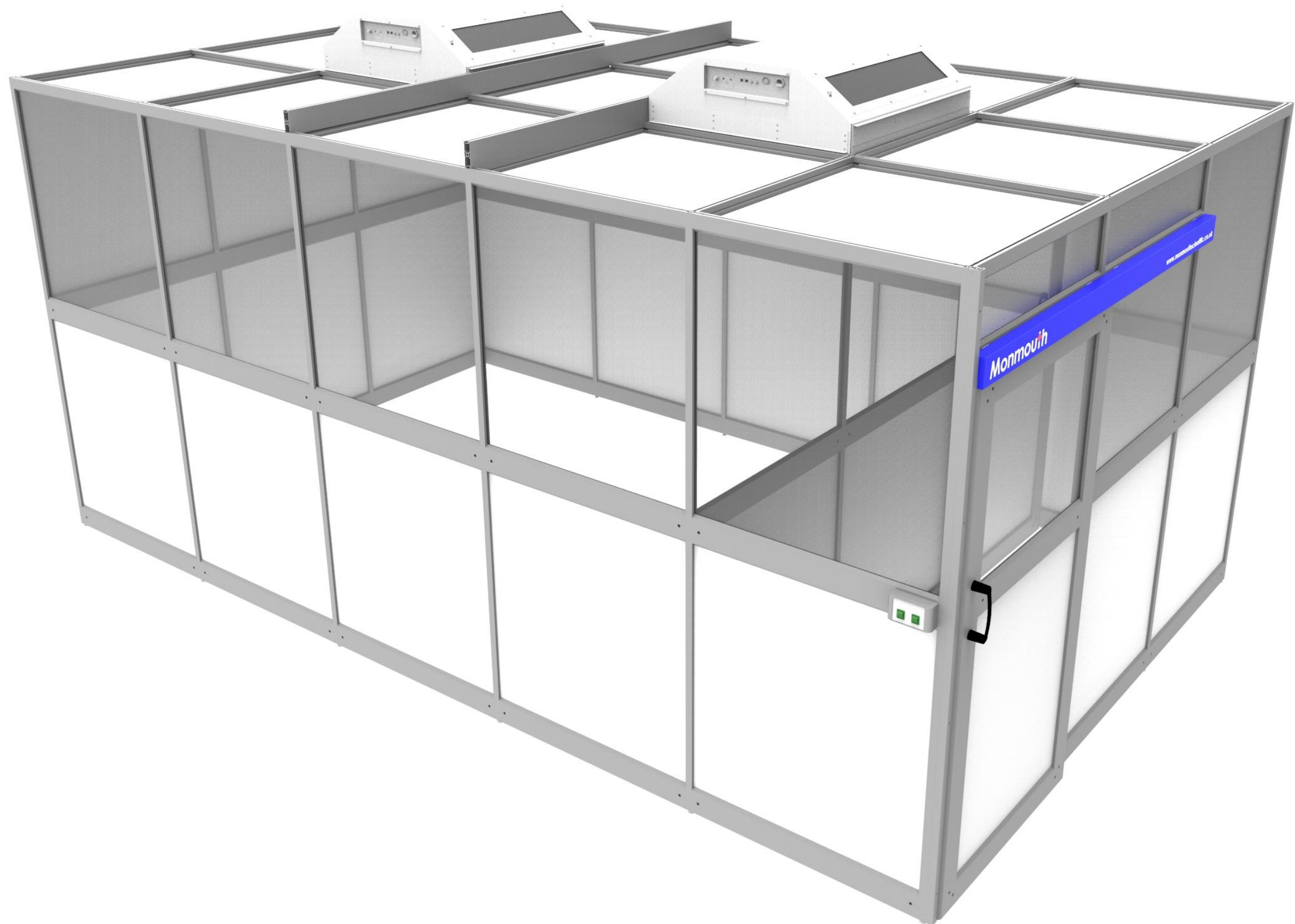

## Questions and Support

Thank you for purchasing a Monmouth Scientific Cleanroom Kit.

We want to ensure you are happy with your purchase. Therefore should you have any questions or require any support on the assembly or operation of your new cleanroom please contact Monmouth Scientific by any of the methods below:

**Telephone:**        **UK 01278 458090**  
                              **International +44 1278 458090**

**Office Hours:**    **8.45am to 5.00pm**

**Email:**             **[info@monmouthscientific.co.uk](mailto:info@monmouthscientific.co.uk)**

**Alternatively, please contact your sales agent.**

**Monmouth Scientific Limited**

Units 5 & 6 Kilinside,

East Quay

Bridgwater

Somerset TA6 4DB

[info@monmouthscientific.co.uk](mailto:info@monmouthscientific.co.uk)

[www.monmouthscientific.co.uk](http://www.monmouthscientific.co.uk)

+44 (0)1278 458090